

## LIONS TO OFFER LIGHT BULBS FOR WORTHY CAUSE

Virgil E. Tompkins and Fletcher C. Waite, co-chairmen of the Bethlehem Lions Club Annual Light Bulb Sale, announce that light bulbs will again be offered on Saturday, Oct. 15, between 10 A.M. and 4 P.M.

Packages offered to the public will contain four 60-watt and four 100-watt bulbs and will sell for \$1.75. Proceeds of the sale will be used for the Club's sight conservation program and other community and welfare purposes.

## DELMAR FIRELADIES TO MEET TONIGHT

There will be a meeting of the Ladies Auxiliary of the Delmar Fire Department on Oct. 13 at 8 P.M. at the fire hall. This will be guest night. Miss Sally Ryan will preside and the feature of the evening will be a toy party. The refreshment committee will be chaired by Mrs. Joseph Furtado, Jr., with Mrs. Basil Evangelisti and Mrs. Vernon Winchester assisting. Mrs. Edgar Van Cott and Mrs. William Contento are in charge of entertainment.

## LEGION AUXILIARY TO MEET OCT. 18

Mrs. Esther Cooke, president of the Nathaniel Adams Blanchard American Legion Auxiliary unit, has announced that the regular meeting will be held on Tuesday, Oct. 18, at 8:00 P.M. at the Post Rooms.

Mrs. Burr Deitz will read the history of the previous year's activities.

## BANTAM LEAGUERS ALSO BREAK HUNDRED

We are delighted to announce the high scores in the Wednesday Bantam League bowling: Allison Jones was the highest girl scorer with 105, and Jim Garb topped all the boys at 110!

# ST. THOMAS PARISH OPENS APPEAL FOR NEW, MORE COMMODIOUS CHURCH



BY THE WAY, SAYS ABBIE UTZ...

## CONGRATULATIONS AND HAPPY 100th BIRTHDAY, MRS. FLEAHMAN!

We'd never had the extreme good fortune nor the pleasure to really meet and visit with someone who is 100 years young. But just this past week this event occurred. The lady who deserves our best wishes is Josephine Fleahman, who celebrated her birthday yesterday,

on Columbus Day. On Oct. 11, the town officials, including Ruth Dickenson, Town Historian, entertained Mrs. Fleahman for luncheon at her home, The Center Inn, on route 9W. Here with her son, Arthur Fleahman, Sr., who assisted us with our

(continued on page 9)

A building fund appeal for the proposed new church to be erected at the parish of St. Thomas, Delmar, was inaugurated recently. The Most Reverend William A. Scully, D.D., Bishop of the Roman Catholic Diocese of Albany, launched the campaign when he presided at the opening ceremonies and imparted his blessings upon the 200 men workers.

The new church will be located adjacent to the Parish House and will face Adams Place. It will provide a seating capacity for approximately 900 persons. Preliminary plans are being drawn by August Lux and Associates, Albany architects. Construction will begin this spring and is expected to be completed by early spring in 1962.

In announcing the plans, Monsignor Rooney, Pastor of St. Thomas Church, remarked, "The present church, which seats 365 persons, was built in 1924 and has served the parish well for many years. With the increased number of parishioners, it became necessary to use our school auditorium for three of the 9 masses which must be celebrated each Sunday. The rapid growth made the need for a new and more commodious church necessary."

Completion of the church will be one step further in the parish building program which has already provided a school and Parish House. Construction cost

(continued on next page)

## WEDNESDAY IS MATINEE DAY: WISH WE COULD GO

There will be a bus trip leaving Selkirk October 19 to New York for shopping or theatre. For further information call Mrs. Peter Mortensen at RO 7-3059.

**SO SORRY...**  
to inconvenience you!,  
**BUT...**  
we are building a bigger and better  
Diner- to serve you in a more pleasing  
way! Your continuous patronage has made  
this all possible... Words will not express  
fully our appreciation  
for the opportunity to serve you  
**"THE BEST - AT A FAIR PRICE"**

**Miss Glenmont Diner**  
ROUTE 9W  
NEAR TOP  
OF CORNING HILL



**(NEW CHURCH)**

for the church will approximate \$450,000. In order to help defray this cost and to avoid an immoderate increase in the parish indebtedness, a building fund appeal has been inaugurated with the sights of the committee set at \$375,000 as its

minimum goal. Committee members have begun visiting fellow parishioners to explain the campaign plan and to ask for their active participation.

**WOMEN'S REPUBLICAN CLUB TO HOLD CARD PARTY & FOOD SALE**

Mrs. David A. Mead, president of the Women's Republican Club, Town of Bethlehem, announces the annual fall Card Party and Food Sale will be held at the Hamagrael School at 8 P.M., Monday, October 17.

**von Bank's TV SERVICE**  
HE 4-5887  
Quality Responsibility Honesty

*The Spotlight* is published every Thursday, by Spotlight, Inc., 154 Delaware Avenue, Delmar, N. Y., Robert G. King, publisher. Deadline for news is Thursday afternoon, one week preceding publication; deadline for display and classified advertisements is Friday afternoon.

DISTINCTIVELY DIFFERENT . . .

**Furs**

JACKETS STOLES

*Wilhelm's*  
Lark St. at Lancaster  
Albany

Phone HE 4-0513

8 10 A&P's Price-Reducing Know-How helps slim down your "Waste" Line and... 3

**FATTEN UP YOUR SAVINGS**

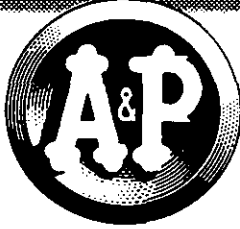
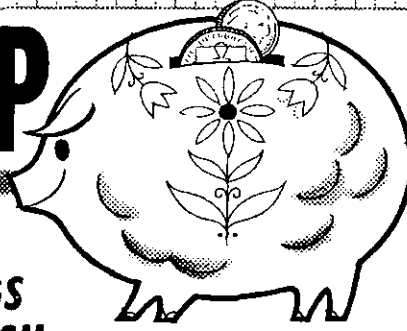

**WHERE SAVINGS ARE CASH SAVINGS**

415 DELAWARE AVE., ALBANY  
**DELAWARE AVE., DELMAR**

**A&P CLOROX**  
This coupon worth 9¢  
YOU PAY ONLY **50¢** gallon jug  
COUPON LIMITED TO 1 ADULT CUSTOMER  
THRU SAT. OCT. 15th AT  
**A&P SUPER MARKET**  
415 Delaware Ave., Albany or Delaware Ave., Delmar

CLIP THESE MONEY SAVING COUPONS

This coupon worth 6¢  
**A&P TIDE**  
GIANT SIZE PACKAGE **75¢**  
COUPON LIMITED TO 1 ADULT CUSTOMER  
THRU SAT. OCT 15th AT  
**A&P SUPER MARKET**  
415 Delaware Ave., Albany or Delaware Ave., Delmar

Mrs. Paul D. McGinnis will be General Chairman, and she will be assisted by chairmen of tickets, prizes, cards and tallies, tables and chairs, membership, jewelry, food sale, and refreshments. First voters from various districts of the Town, will assist in serving refreshments.

**PROGRESS CLUB'S MUSIC GROUP TO MEET OCT. 17**

The Music Group of the Delmar Progress Club will have its first meeting, Monday afternoon, Oct. 17, at 2:00 P.M. in the Delmar Public Library.

Mrs. John M. Ganey, chairman, has announced the speaker will be Edgar S. Van Olinda, well known musician and music critic of the Albany Times-Union.

Mrs. Archie H. Robertson is chairman of hostesses for the tea hour following the meeting,

and she will be assisted by Mrs. Robert Selkirk, Mrs. C. A. Blanchard and Mrs. Charles W. Noyes.

**AUNT DINAH, PLEASE COPY**

The Unionville Home Demonstration Unit recently held an auction at the home of Mrs. (continued on next page)

\*\*\*\*\*

**IS YOUR FIRE INSURANCE**

*enough to rebuild at TODAY'S values? Improvements, alterations, inflation -- all affect it!*

*Consult us today -- no obligation!*

HE 9-4581

**BUTLER and BROWN, Inc.**

244 DELAWARE AVENUE  
DELMAR, NEW YORK

\*\*\*\*\*



**EXPERIENCED MAGICIAN**  
for  
**ADULTS & CHILDREN'S PARTIES**  
also  
Churches, Clubs, Organizations  
from **\$10.00** IV 2-5843



**OCTOBER HARVEST FOR SAVERS**

**DEPOSITS**  
made on or before  
**OCTOBER 17**  
earn dividends from  
**OCTOBER 1**



Current Dividend

**3 1/2 %** per year

**CREDITED and COMPOUNDED QUARTERLY**

**OPEN** your account today in 100-year-old City & County Savings Bank. Assets over \$95,000,000. You'll enjoy saving here and will certainly approve our prompt, friendly service. Simply fill in and mail coupon below with deposit of \$5 or more. We'll send your passbook and postage paid banking by mail envelopes by return mail.

**Family FISH FRY**

**EVERY WEDNESDAY NIGHT-4 'TIL 9**

**All You Can Eat! \$1.00**

**Children Under 12 . . . 65c**

**HOWARD JOHNSON'S**

"LANDMARK FOR HUNGRY AMERICANS"

**Southern Blvd. Rte. 9W**  
**opposite THRUWAY EXIT #23**

**CITY & COUNTY Savings Bank**

FOUNDED 1850

**DOWNTOWN 100 STATE STREET**

**UPTOWN 301 NEW SCOTLAND AVE.**

**ALBANY, N. Y.**

MEMBER FEDERAL DEPOSIT INSURANCE CORPORATION

**MAIL THIS COUPON TODAY**

City & County Savings Bank  
100 State St., Albany 1, N. Y.  
(or) 301 New Scotland Ave., Albany 8, N. Y.

Send New, FREE Banking by Mail Booklet.

Enclosed is \$..... Please open a savings account for me as checked and mail passbook to address below.

Individual Account in my name.

Joint Account with.....

Trust Account for.....

Name.....

Address.....

City..... Zone..... State.....

*If you send cash, use Registered Mail*

2

# BUSINESS MEN!

*Special Luncheon*

SERVED MONDAY thru FRIDAY  
12 P.M. to 2 P.M.

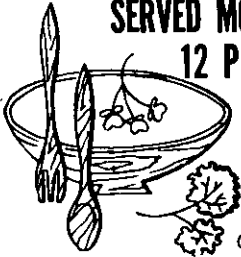

**90¢**

CHOICE OF:  
HOME MADE SOUP o ENTREE (a daily feature) o BEVERAGE & DESSERT

**TOLLGATE**  
SLINGERLANDS

(HOME UNIT)

Ernest Muzzeon on Spore Road. Mrs. H. Paige spoke on the art of making quilts, an art which she will teach in the coming months. Anyone who is interested in this project may contact Mrs. Chauncey Welch at HE 9-3654.



**French**  
**FURNITURE UPHOLSTERING**  
REPAIRING . REFINISHING  
We like to restore antique furniture to its original state ...  
838 BROADWAY HEmlock  
RENSSEL AER, N.Y. 4-0633

T H E S P O T L I G H T

**DELMAR DAY UNIT TO HEAR MRS. MUNTZ**

The Delmar Day Unit of the Albany County Extension Service will hold its monthly meeting at 1:30 P.M. on Friday, Oct. 14 at the Delmar Library.

Mrs. John Muntz, president of the League of Women Voters will be the speaker. Guests are invited.

**BETHLEHEM GRANGE NEWS**

Officers elected at the Sept. 24 meeting of the Bethlehem Grange #137 include: Master, Richard Bennett; Overseer, Harold Grandy; Lecturer, Lois Marie Baumes; Steward, John Barth, Jr.; Assistant Steward, Francis Kolb; Chaplain, Dorothy Hill; Treasurer, William Baumes; Secretary, Leona Carr; Gatekeeper, Roger Hill; Ceres, Dorothy Bennett; Pomona, Molly Gleason; Flora, Hedwig Barth; Lady Assistant Steward, Mary Carr; Executive Committee for three years: Harold Williams; and Juvenile Matron and Patron, Helen and Winston Raynor.

Receive **Deposits** Made On or Before **October 17**

Receive **Dividends** from **October 1**

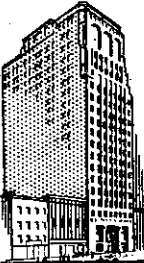
**The HOME Savings Bank**  **3 1/2 PER CENT PER YEAR**

(Member Federal Deposit Insurance Corporation)

**DOWNTOWN** 11 NO. PEARL ST.  
**UPTOWN** 77 CENTRAL AVE.  
Open Thursdays until 8 P. M.

Pick your favorite piece of **corned beef, point brisket, sirloin, rump, eye of round & bottom round**

HO-36424

**MC CARROLL'S SUPER MARKET**  
Since 1921  
**THE CORNED BEEF PALACE**  
272 Second Ave., Albany

Installation will be held on Saturday, October 22. Please bring a covered dish.

**PLAYERS ANNOUNCE CAST FOR "JUNO"**

The cast for *Juno and the Paycock* has been announced by the Slingerlands Community Players who will present Sean O'Casey's modern classic on Oct. 28 and 29 at the Senior High School.

Appearing in the title roles will be Helen Cross and Jack Clark. Their son and daughter will be portrayed by Jack Gunter and Lis Cook. Bill Heenehan will play Joxer and Betty Taylor will be Maisie Madigan. Also in the cast are: Bill Kraus, Graham Zeh, Marge Guntner, Hank Maloy, Charles Losacco, Mary Nugent, Pat Smith, Bill Morrison, Craig Smith, Art Ploetz, Bob Cook, Will Green

and Al Basch. Ruth Wilber will direct.

Tickets may be obtained now by writing to the Slingerlands Community Players, Slingerlands, or — during the two weeks before the performances — at Mullens Drug Store and the Delmar Public Library.

**NEWCOMERS TO VIEW FALL FASHIONS**

On Wednesday, Oct. 19, mem- (continued on next page)

**REFRIGERATION & TV SERVICE**

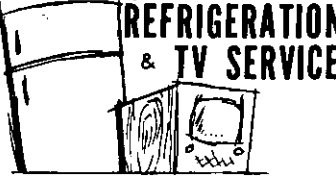

HOUSEHOLD • COMMERCIAL  
ALL MAKES • ALL MODELS  
OVER 10 YRS. EXPERIENCE  
**VALLEY SERVICE Co.**  
750 DELAWARE AVE.  
DELMAR, N.Y. HE 9-5537  
H. N. KLETT Jr., Mgr.

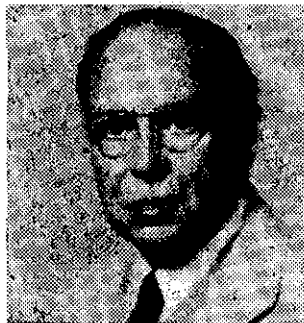

Contrary to all previous reports I have not retired and have no intentions of doing so.

**Henry J. Evans**

Optometrist

Do you take the same care in selecting the optometrist to examine your eyes as you do in selecting a dentist or physician?

**Three New Services for the Convenience of Our Patients...**

Eye examinations Thursday evenings by appointment.

Free parking at Minit Man Parking Lot, Sheridan Ave. and Chapel St.

First Trust financing at no cost to you.

**HENRY J. EVANS**  
78 NO. PEARL ST., ALBANY  
PHONE 3-1707

**ALBANY PUBLIC MARKETS PLATFORM PLEDGE...**

**ALBANY PUBLIC MARKETS** **100% SATISFACTION GUARANTEED**  
*... and with a smile!*

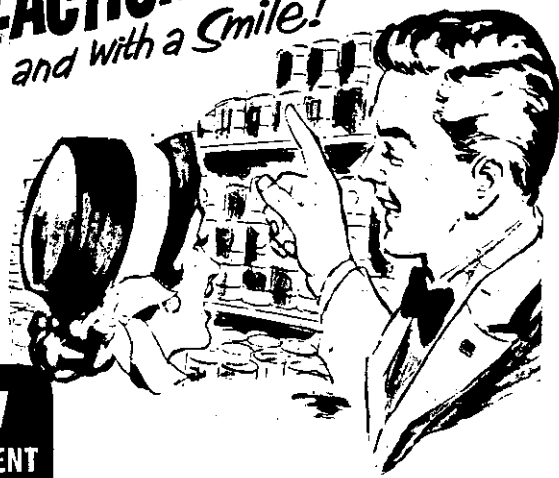

**NOW**  
3 - CONVENIENT LOCATIONS TO SERVE YOU

**WESTGATE SHOPPING CENTER**  
ALBANY

COLUMBIA STREET, RENNELAER

DELAWARE AVENUE, DELMAR

**IT PAYS TO SHOP YOUR BIG FRIENDLY ALBANY PUBLIC MARKET FOR---**

- greater selection
- finest quality
- lower price
- top value stamps



**ALBANY PUBLIC MARKETS**

OPEN DAILY 9 to 9

SATURDAYS 9 to 6

★ **BRANIGAN'S ALTAMONT Inn**  
 (Formerly the Wagon Road Inn)  
 ★ COMPLETE DINNER  
 ★ **BROILED ALASKAN KING CRAB \$3.50**  
 ★ **ROAST PRIME RIBS OF BEEF \$3.75**  
 ★ Dine in the cool air of the Helderbergs while enjoying  
 a panoramic view of the Hudson Valley. Closed Mondays  
 ★ LUNCHEON • DINNER • COCKTAILS  
 Facilities for parties receptions and anniversaries  
 ★ RT. 156 • UN 7-8063 • ALTAMONT — OPEN ALL YEAR

(NEWCOMERS)

Members and guests of the Tri-Village Newcomers Club will join the Albany group for an evening of fall fashions at the Manger DeWitt Clinton Hotel. Dessert will be served at 8 o'clock, preceding the fashion show to be presented by W. M. Whitney & Co.



**KENNETH PARKER LEAVES FOR 2 YEARS IN GERMANY**

Army Pfc. Kenneth B. Parker, son of Mr. and Mrs. Bernard Parker, Glenmont, was home on a 40 day leave from Fort Erwin, California. He will spend the next 2 years in Germany with the Army.

**POSTMASTER SMITH REPORTS STEADY RISE IN MAIL VOLUME**

A new all-time high in the nation's mail volume was reached during fiscal year 1960 ending June 30, continuing the steady upward trend of the past 7 years at a rate which even exceeds the population growth, according to information from the Annual Report of the Post

Member of Television Service Assn.

**LEW HAYES TRI-VILLAGE TV**

HE 9-1070  
 23 Bridge St. Slingerlands, N.Y.

**NEED A FAST CAR WASH?**

**TRY THE NEW MINUTE MAN**  
 590 CENTRAL AVE., ALBANY

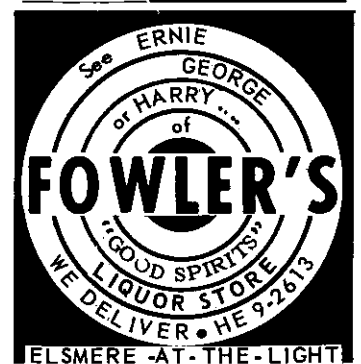

**WIN A FREE DRYER! Entry blank at our store.**

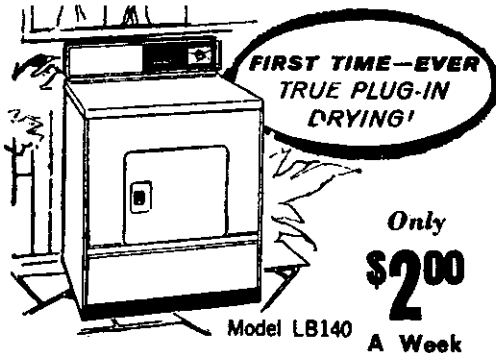

NEW 1961  
**Hotpoint**  
 115-VOLT  
**SPEED-FLOW DRYER**

- Gives you the fastest 115-volt drying—ever
- New Hotpoint Speed-Flow system gives you faster drying on only 115-volts
- Automatic timer; big lint screen
- 3 Pushbutton temperature controls; special Fluff Cycle

Only **\$200**  
 A Week

Model LB140

**HOPKINS APPLIANCE**



239 Delaware Ave. Elsmere  
 HE 9-4558

**AT W. G. MORTON**

WE WILL REPLACE YOUR OLD BURNER WITH A BRAND NEW OIL BURNER

**\$50.00**

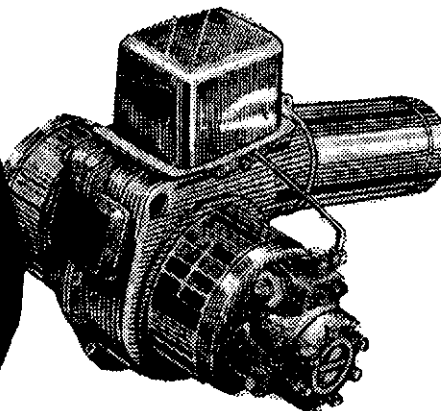

Ideal for use with either Warm Air, Hot Water or Steam Heating installations

You can't afford to waste FUEL DOLLARS with a worn-out burner at this sensational price. This offer is good only with a signed 1-year fuel oil contract.

**W. G. MORTON**

80 No. Manning Blvd. Albany, N. Y.  
 Phone HE 8-7821

Office Department which has been made available to Acting Postmaster Kenneth R. Smith.

Although subject to last minute revisions, the year's total has been estimated as 63.6 billion pieces of mail which includes about one billion pieces of parcel post. It was stated that this would mean an increase of nearly 25 per cent over the corresponding figures for 1953 when the annual volume was 50.9 billion pieces.

During the same period, it was pointed out, the revenue of the Department also has shown an impressive gain with an increase from \$2,091,714,000 in fiscal year 1953 to \$3,276,800,000 for fiscal year 1960.

Here in Delmar, receipts of the post office climbed from \$65,000 in 1953 to \$110,000 last year.

**IN OUR MAIL...**

Among this week's interesting letters were two which viewed with alarm the imminent congestion of Delaware Ave. One, which waxed wroth on the subject of broken ordinances was signed "Anonymous" and could not be considered for publication. The other, which contained a thorough analysis of the building and traffic situation and offered several palliative suggestions, was much, much, much too long for our modest allotment of space.

Thank you, Mrs. Richard Long, for your kind letter and congratulations on the success of the New Scotland Presbyterian Church Bazaar. And thanks to ex-copy-gal-who-still-writes-persuasive-copy Mrs. Sidney Vunck for bringing us up to

(continued on next page)



**FLUFFY DUCK** says:

**“An AUTOMATIC WASHER-DRYER takes the Work out of Washday!”**

**A**NY time is wash time with a combination automatic washer-dryer. Toss in the clothes, press a button and forget your laundry problems. Want to pick up the children at school? Go ahead — your wash will be clean and dry when you return. Here's an appliance that really works for *you*.

Towels will come out fluffier than our Fluffy Duck. Do cotton knits, corduroys and flannels without any ironing. Damp-dry clothes are ready for ironing. Wash day (no matter how many) will be a brighter day for you, with time left for the hundred and one things that need doing — more time for your family, too.

Take your husband to your appliance dealer and find out how easy it is to own a wonderful hand-saving, work-saving, automatic washer-dryer. Your dealer will arrange easy terms.

**WIN A FREE DRYER**

or Combination **WASHER-DRYER**

You can be one of the lucky winners of a dryer or combination washer-dryer! It's easy to enter — just fill out the official entry blank available now at most appliance dealers. Nothing to buy. No statements to write, no jingles to complete. See the official rules on entry blanks.

**ENTRY BLANKS** at most appliance dealers . . . Get Yours Now.

**Harold:**  
Folks tell me our home-cooked hot dishes are tops! Hearty beef stew on Wednesdays, tasty meat loaf on Tuesdays.

**Ralph:** Gives hungry customers two more good news days!

**COFFEE SHOP**  
283 Delaware ave., Elsmere  
We close at 3 P.M. Saturday

**NIAGARA**  **MOHAWK**

BUSINESS MANAGED — TAXPAYING

**Bilco**

AMERICA'S FINEST  
BASEMENT DOOR

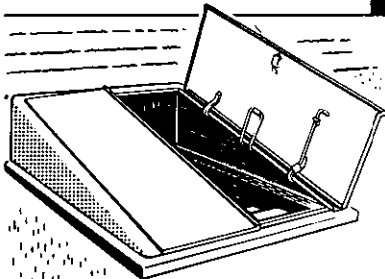

ALL STEEL • PERMANENT  
SPRING-BALANCED

Plan the basement of your new home with a modern all steel Bilco Door. Its direct access supplements the inside stair — makes your basement useful, convenient and safe. Call us for free, informative folder.

Call us for free "How-to-install-it" folder, or we can suggest a competent workman.

**F.F. CRANNELL**  
LUMBER CO.

SINCE 1849

278 Delaware Ave., Delmar

PHONE HE 9-9927

Mon. thru Sat. 8 AM to 5:30 PM



LET US HELP YOU WITH  
YOUR HOME REPAIRS

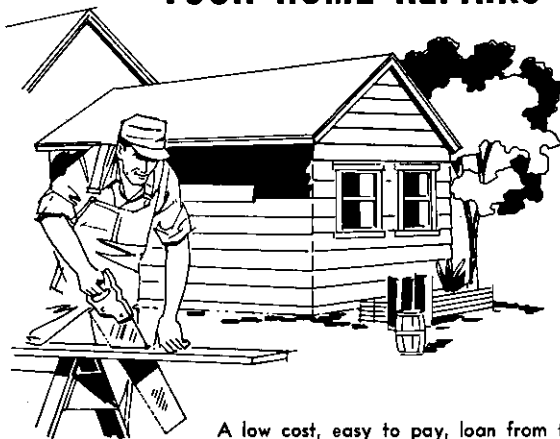

A low cost, easy to pay, loan from this Bank, with no mortgage required, will help you to make those much needed repairs and improvements to your home.

COME IN AND TALK IT  
OVER WITH OUR OFFICERS



**Mechanics Exchange  
Savings Bank**

ALBANY, NEW YORK

47 STATE STREET - 450 BROADWAY

111 WASHINGTON AVE.

Established in 1909 by the merger of  
THE MECHANICS AND FARMERS SAVINGS BANK, CHARTERED 1855 — and THE ALBANY EXCHANGE SAVINGS BANK, CHARTERED 1859

MEMBER FEDERAL DEPOSIT INSURANCE CORPORATION

(MAIL)  
date on the fine day enjoyed at  
the Voorheesville First Meth-

odist Church's Bazaar and Auction — Editor.



Pictured are (left to right): John J. Farrell, General Supervisor of Building Construction; John T. Carroll, toastmaster, Mr. Woodin, Mrs. Woodin, Charles S. Kawecki, Chief Architect.

**TESTIMONIAL LUNCHEON HONORS  
EVERETT W. WOODIN UPON RETIREMENT**

A testimonial luncheon was held recently to honor Everett W. Woodin, on the eve of his retirement from his position of Associate Architectural Estimator with the Division of Architecture, New York State Department of Public Works.

Mr. Woodin, who resides in Slingerlands, has been Chief Estimator in charge of all cost and budget estimating on State Building Construction for over 31 years.

The luncheon was attended by 130 persons, and a gold watch and several other gifts were presented to Mr. Woodin.

ALBANY  
GARAGE  
N.Y.

DODGE - DART - LANCER - SIMCA  
370 BROADWAY - MENANDS, N.Y.  
HO 3-4233

"each car personally offered  
by GEORGE MORRIS  
manager"

SUPER AUTOMART

**'57 RENAULT**

Dauphine 4 door sedan,  
heater, defroster, other  
extras. Ideal 2nd Car.

\$595

**'53 CHEVROLET**

210 4 door sedan, 2 tone  
green, radio, heater, auto-  
matic transmission. Excel-  
lent running car.

\$395

**'55 DODGE**

Coronet 2 door hardtop,  
white, black and rose,  
radio, heater, automatic  
transmission, many other  
extras

\$595

**'56 MERCURY**

4 door sedan, blue & ivory,  
heater, defroster, auto-  
matic transmission. Abso-  
lutely spotless.

\$795



**(ABBIE UTZ MEETS MRS. FLEAHMAN)**

data, Josephine Fleahman has lived for the past 12 years. We know there was much reason to celebrate and the guest of honor received flowers and many messages of congratulations.

Mrs. Fleahman was born Josephine Phillips down New York way and moved to Hudson upon being married to Herbert Fleahman, a cigar manufacturer. There were two children, but Arthur, Sr. is the only one living.

Just around noon during our visit with both Arthurs, senior and junior, Mrs. Fleahman joined us for her brunch. She knows all the personnel and reads the newspaper, watches TV some, and still mends, too. Naturally Arthur, Jr. was quite busy all this while with the luncheon crowd.

The evening of Oct. 12, Mrs. Fleahman's family entertained, with 5 generations represented. We know what an historic moment this was for all present. Again may we say Happy One

**Hundredth Birthday Wishes . . .**  
By the way.

The Nimble Thimble 4-H Club of Delmar has just elected new officers. They are as follows: President — Nancy Alford; Vice President — Barbara Buttercase; Secretary — Nancy Casper; Treasurer — Joan Wrzenski; News Reporter — Patty Clark, and Song and Game Leader — Linda Lee. In the recent Altamont Fair the club exhibited many things, ending up with 26 blues, 36 reds, and 14 greens. Two of these entries went to the New York State Fair. They both won red awards . . . Congratulations young ladies!

Mrs. Hank Kiernan of Sibley Place, Delmar just let us know the winners from the latest

Newcomers Bridge Group . . . Mmes. Charles Reinhart, Richard Phelan, Joseph Fitzgerald, Phyllis Ryan, Kenneth Gamble. Good turnout too, in spite of the virus that is about.

We would like to welcome Mrs. Clayton Smith of Elsmere home from the Albany Hospital  
(continued on page 11)

after  
**OCTOBER 15th**  
**BOB'S**  
**AUTO TOP SHOP**  
will be located at  
**280 DELAWARE AVENUE**

**rod kermani**  
presents tremendous values on excellent  
**orientals**  
in all sizes and colors  
Room Size Orientals as low as **\$189 00**  
a complete line of famous name  
broadloom carpets  
Tues & Thurs 11 to 9  
Daily 11 to 5:30  
... an Eastern touch for a Western World...  
**k. kermani**  
**oriental rugs**  
Incorporated  
3905 STATE ST.  
(Albany-Scht'dy Rd., Stop 3  
Scht'dy Albany  
EX 3-6884 IV 2-0457

**JOAN LUND**  
SCHOOL of the DANCE  
**NOW OPEN**  
at  
154 A DELAWARE AVE.,  
NEXT TO THE PLAZA  
**BALLET TAP MODERN JAZZ - BALLROOM**  
★ SPECIAL ★  
ADULT BALLROOM  
**\$3.00 per couple**  
FORM YOUR OWN GROUP NOW AND LEARN THE NEW DANCE STYLES  
REGISTRATION & INFORMATION  
HO 2-9375 • IV 9-1866  
IV 2-4643

**A "Sanitized Pillow is a sterilized Pillow"**  
**HUSH-HUSH ITEM!**  
**"Your guest's nose knows!"**

One of the most neglected items in the household is the feather pillow. It stands to reason that no pillow can be slept on 165 nights a year without absorbing a subtle tell-tale odor from constant contact with perspiration, hair and skin oils.

True, your sense of smell may have become inured to this condition, but it will hardly go unnoticed by visiting guests.

But that's not all - and we're going to let you in on a "trade secret" It may surprise you to know that from every pillow we sanitize on our modern scientific equipment (exclusive with Killip) - we usually vacuum out at least a cupful of broken quills, dust and foreign residues!

Pardon us for raising this touchy subject, but we thought you'd like to know You will also be glad to know that we can take a lifeless matted down old pillow, steam sanitize and dry every feather in warm air currents to restore natural curl, and return your old pillow absolutely hospital sterile and comfortably resilient for only \$1.95 per pillow.

76-80 GREEN ST. **Killip LAUNDERING COMPANY** ALBANY, N.Y.  
CALL HO 5-3311  
IN TROY and SCHENECTADY Call Enterprise 9-624  
FREE PICK-UP and DELIVERY IN SUBURBS, TOO

# MAIN-CARE makes sure you get your money's worth!

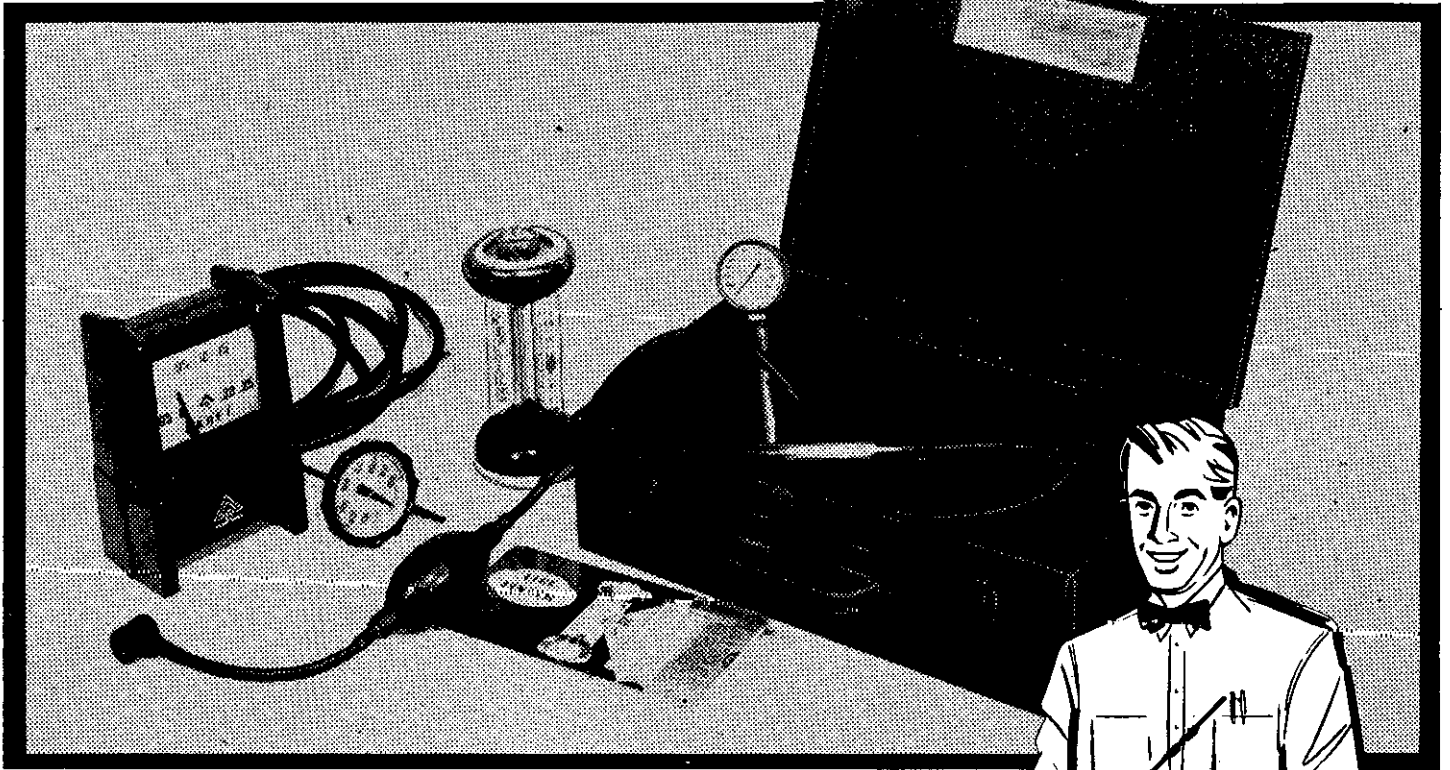

Free Burner Efficiency Test guards against oil waste . . . cuts fuel bills.

The instruments shown above are used by our servicemen to test the efficiency of oil-burners belonging to MAIN-CARE customers. Experts in their field, these are the men who make sure that MAIN-CARE families get all the heat possible from the fuel they burn. You see, an oil-burner is similar to any other piece of mechanical or electrical equipment. Just because it runs is no indication that it is operating properly and efficiently. An improper adjustment of the carburetor of your automobile will result in poor mileage from the gasoline consumed. By the same token, a faulty adjustment of your oil-burner, not discernible by the usual inspection methods, will result in increased fuel consumption . . . less heat.

Specially trained MAIN-CARE servicemen carefully test and adjust the oil-burners of our customers after every cleaning, more often if necessary. And this extra MAIN-CARE service is performed *free of charge*. MAIN-CARE families know that their heating system is at the peak of operating effectiveness and that they're getting all the heat they're paying for. Why don't you take advantage of extra MAIN-CARE service, too? It just makes good sense to be sure you get your money's worth.

You get more care with **MAIN-CARE**

**MAIN BROS. OIL CO., INC.**

318 Delaware Ave.

Delmar, N. Y.

**BAKER OIL CO., INC.**

318 Delaware Ave.

Delmar, N. Y.

**S. V. DAY OIL CO., INC.**

Route 143

Ravena, N. Y.

THE SPOTLIGHT

(ABBIE UTZ)  
tal. Wonderful to have you home too, Ginny. Hurry back, 'cause Welcome Wagon misses you also.

Tonight at the Aurania Club at 6:30 P.M. Albany Panhellenic Association of the Capital District will have their Fall dinner-meeting. Dr. Robert Rienow, Professor of Political Science at State University College for Teachers will discuss his latest book "Our Life With the Atom." His wife, and co-author, Mrs. Leona Rienow, a member of Panhellenic will also be a guest at this meeting. Should be an interesting evening. Check with Mrs. Paul Distelhurst in the city for any last minute details.

The Wayne Coopers of Tri-Village were out to Delaware, Ohio to visit their son, a freshman at Ohio Wesleyan University. Wonderful spot and understand Wayne likes it too.

*Engaged!* Carolyn Rae of Feura Bush Road, daughter of Mr. and Mrs. James E. Smith to Norman J. Franz, Jr., son of

Mr. and Mrs. N. J. Franz of Elm Ave., Delmar. A January wedding in St. Thomas Church, Delmar is planned. Norman is a graduate of BCHS.

*Wedding Bells for Glenmont Girl* — The marriage of Marie Plass, daughter of Mr. and Mrs. Edwin A. Plass of Glenmont and Dale T. Rice, son of Mr. and Mrs. Delbert Rice of Delmar, took place in the First Reformed Church of Bethlehem with a reception in the church hall.

(continued on next page)

Mr. VAN, The Gardener, SAYS:  
**Fall Clearance Sale**  
any potted rose bush  
shrub or evergreen  
**\$1.00**  
PUMPKINS



**VAN ALLEN FARMS**  
ON 9W - FIRST FARM NORTH OF JERICO DRIVE-IN  
Telephone ROger 7-9101  
OPEN SUNDAY

**Hamele's** MEATS OF QUALITY

PHONE HO 3-4244

Dubuque Brand

**DAISIES 63¢**  
2 lb. avg. 1 lb.

Hamele's LEAN

**STEW BEEF 89¢**  
lb.

Use either for Stew or Hamburg  
Every Pound Ground to Order  
None Pre-Packaged

**MAXWELL HOUSE COFFEE 69¢**  
1 lb. tin

PHONE HO 3-4244

**Hamele's** MEATS OF QUALITY

542-546 DELAWARE AVE.  
2½ blocks South of 2nd Ave.—Parking

**Use the State Bank Health Plan!**



It didn't hurt a bit! . . .

the dentist's bill, that is. That's because my mom and dad took our dentist's advice and they make regular monthly payments thru the State Bank Health Plan. Ask YOUR dentist about this plan. Maintain YOUR dental health!

Serving Northeastern New York State

State Bank of Albany

Chartered - 1803

MEMBER FEDERAL DEPOSIT INSURANCE CORPORATION



TUNE IN  
**Geoff Davis**  
**Corina Cigars**  
 Radio Station WOKO  
 Monday thru Saturday 7.00 to 8.30 A.M.

**SOIL SAVER! • TAWASENTHA FARMS**

Soil Saver, a natural organic plant food made from humus rich compost and sone dust with abundant major and minor elements.  
**JUST WHAT YOUR LAWN & FLOWERS NEED!**

Delivered in Tri-Village  
 Phone HE 9-2798 or HE 9-5626 CLOSED SUNDAYS  
 North Street ½ Mile from RR Sta. Delmar.

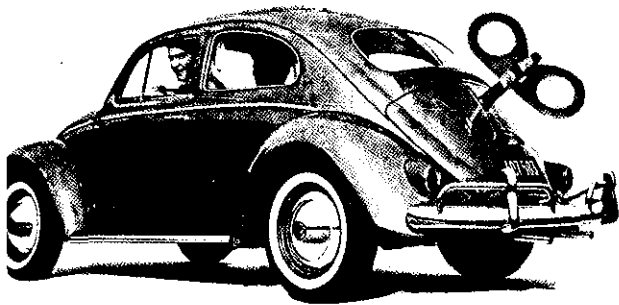

**it isn't so**

That winding key you've been seeing on some VWs is not standard equipment.

It's put there by proud Volkswagen owners, who go around telling their friends they get 40 miles on one winding.

That isn't quite true.

The correct figure is about 32 miles (regular driving), and it requires one gallon of gas.

Otherwise, the winder gives you a pretty good idea of how economical it is to own and operate a Volkswagen.

The VW engine in the rear is air-cooled. No water to boil over or

freeze. No anti-freeze. No radiator expenses. No radiator.

Engine friction is so low that top speed and cruising speed are one and the same. A Volkswagen can run wide-open all day long without running up a repair bill. And it uses practically no oil between changes.

A VW costs \$1,565\* including heater. Leatherette upholstery is optional, and so are white walls, side view mirror and radio. Outside of that, we can't think of anything else you might want.

Except possibly that winding key.

**ACADEMY MOTORS INC.**  
 TROY - SCHENECTADY ROAD, LATHAM, N.Y.  
 STATE 5-5581 . AUTHORIZED DEALER



(ABBIE UTZ)

Welcome to Phyllis and Henry Dorr formerly of Albany who are new neighbors on Lyons Ave., Delmar. With them will be Tom and Jack and Bill, a junior at Bucknell.

Guess what the boys and girls of the Massachusetts 4-H Clubs will introduce . . . a new product, *cranberry table syrup*. Just made its debut! This will help support the State 4-H work. It is brilliant red, the natural fruit color, and may be used on pancakes, waffles, grapefruit or other fruit, ice cream, cake or other desserts. Looks will make it delicious . . .

Another good Open House crowd at First Methodist Church, we're informed . . . Senior Class play tryouts and those selected will be out soon . . . for The Bells Are Ringing! Ding Dong. Seniors taking Regent Scholarship Tests like mad this past week (xx) for good luck.

**SENIOR AND JUNIOR HIGHS**

This Saturday the Eagles travel to Mohonoson for a tough football game. This year the team has some tough opposition,

IF IT'S  
**LAMP SHADES**  
 SEE  
**THE LAMP POST INC.**

Over 5,000 shades to choose from.  
 All sizes, shapes and materials.  
 Open: 12 Noon - 9 p.m. Mon. - Fri.  
 Saturday 11 a.m. to 5 p.m.

½ Mile North of the Circle  
**LATHAM, N. Y.**  
 State 5-9228

**AMOCO**

The first name in Heating Oils and Gasoline

**Amoco Heating Oil like Amoco Gasoline**

**ASSURES DIVIDENDS IN**

**Comfort, Economy and Cleanliness, through careful Refinement without additives.**



**McEnaney Service ASSURES**

Low Cost, Customer Satisfaction, Twenty-four Hour Emergency Attention for all makes of Burners. Budget and Charge Accounts solicited, no interest or penalties added.

For detailed information CALL  
**IV 9-3266**

**AMOCO** **McEnaney Oil Corp.**

179 No. Main Ave., Albany 6, N.Y.  
 "Oil Heat has been proven best"

THE SPOTLIGHT

but they're fighting for all they're worth.

Rumors — it has been rumored that the junior class is having their card party tomorrow night . . . Men's Association meeting Tuesday, the 18th.

There isn't much going on this weekend so maybe we'll review some events of the past couple of weeks . . .

We lost our first football game to Shaker — it was a "slaughter." We don't believe in superstitions, but they had trouble lighting the bonfire at the Pep Rally the night before and who knows? Might it have been an omen? We estimate that there was at least two-thirds of the enrollment of both the junior and senior highs there.

The Sophomores got together on Sept. 30 and from what we are able to tell, they had a real blast.

There was a tremendous turnout for the "Daisy Mae Drag," Oct. 1. We guess they all wanted to find out who was going to be "Daisy Mae, Lil Abner, Moonbeam, and Tiny Yokum."

Some were surprised, but many were happy when the winners entered the dining room — Linda Moak, Bruce Secor, Sandy Rogers, and Mike Mosher — respectively.

B.C. won its second football game on Oct. 1. It was a tight game all the way, but the Eagles pulled ahead to win 2-1.

—Ron Denham

\* \* \*

The date on the Canteen Council roller skating party has been changed from October 14 to October 15. By the way, don't forget to get your Canteen Card! They're really worthwhile. You get an awful lot of enjoyment from their benefits. Ask your Canteen Council representative about Saturday morning bowling at Sporthaven.

Just a little word of thanks to the teachers who had the World Series piped into their homerooms. We don't know the final score, but we hope . . . no, we must be impartial!

Remember — this is your column, Junior High students! Nobody seems to be giving us

anything to write. We searched high and low this week, but nobody had anything for us. We must have news; we can't base the whole column on our personal opinions. Any teachers, club sponsors, club members — please tell us all about your organization and its activities!

Help! If you want this column to survive. — David DePorte [Editor's note: If he doesn't learn to spell "column" soon, it won't survive.]

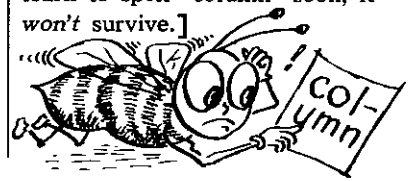

## 2 G.L.F. REDI-GRIPS

PLUS A BRAND NEW WHEEL

\$39.95 PLUS TAX



TUBE TYPE 670 X 15

TUBELESS \$46.95 PLUS TAX (Black Side 670 X 15 or 750 X 14 Walls)

You get an extra wheel when you buy two Redi-Grip Snow Tires.

We mount and balance one Redi-Grip on your new wheel, the other on your spare, without charge.

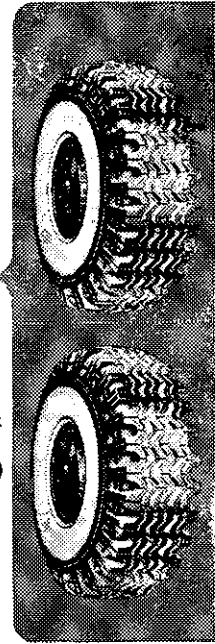

WITH TWO WINTER TIRES MOUNTED AT ALL TIMES

1. Tires are permanently mounted,
2. . . permanently balanced
3. . . and if you want to change the tires yourself, you save a third garage charge — putting on the wheels.
4. No waiting in that long "first-snow line-up" at your garage.
5. Because the tires are not mounted and remounted many times, there is no danger of a damaged "bead" which usually results in tire failure blowouts.

### "THE TIRES"

- Nylon cord construction gives extra protection against impact breaks.
- Sipes . . . slotted traction units, putting many extra gripping edges on the road for safe, sure traction.

SPECIAL SALE PRICES OF COURSE . . . ON WHEELS OR TIRES WITHOUT WHEELS. WE ALSO HAVE 13" SIZES FOR THE NEW COMPACTS.

BEST IN THESE PARTS FOR COLD WEATHER STARTS G.L.F. BATTERIES guarantees range from 2 to 3 years. G.L.F. ANTI-FREEZE Reg. \$.95 gal. Perma. \$1.89 gal.

## WINTERIZE AT G.L.F.



HO 3-6590. Open Sun. 10 A.M. to 5 P.M.

# FOR QUALITY AND VALUE BLACKSTONE CIGARS

EMPIRES 2 for 25¢

KINGS 3 for 50¢ • CORONAS 3 for 55¢

(state tax included)

We'll make

your motor sing

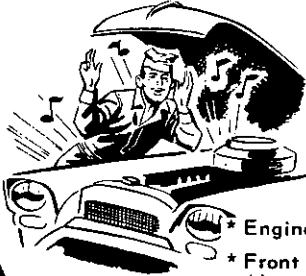

\* Engine Tune-up  
\* Front End Alignment

\* Automatic Transmission Service  
Modern Equipment  
Skilled Mechanics

## BAILEY'S GARAGE

Phone Delmar 9-1446  
Oakwood Rd., Elsmere



# Freihofer's

DELICIOUS BREAD, ROLLS & CAKE

Everyone's Talking About . . .  
**FREIHOFFER'S NEW SUNBEAM BREAD**

**DAILY DELIVERY TO YOUR HOME**  
**PHONE HO 3-2221**



**GEORGE WENGER HONORED BY NEW YORK STATE BAR ASSOCIATION**

Albany attorney George F. Wenger, of 10 Darroch Road, Delmar, is shown receiving a plaque honoring his years of service as vice-chairman and chairman of the NYSBA's Committee on Professional Ethics. At right is NYSBA Executive Director John E. Berry, of Delmar.

**BETHLEHEM LUTHERAN CHURCH RALLY DAY**

The Sunday School of Bethlehem Lutheran Church held its annual Rally Day exercises Oct. 2nd. This Sunday School holds classes every Sunday throughout the year, and this day is special because it is the day that the children move up in their classes, and participate as a body in the church worship service. There are 16 teachers and a total of 106 enrolled children, ranging from nursery class age through the young teens.

This year the Sunday School is again under the supervision of Alton G. Marshall, assisted by John Gardiner. Also members of the staff are: Mrs. Frank Markus, Mrs. Arthur Dill, Mrs. Henry Finger, Mrs. Erich Krugman, Mrs. Nelson Williams, Mrs. Elmer Becker, Mrs. Charles Herrick, Mrs. Walter Wright, Mrs. Ernest Gall, Mrs. William Bailey, Mrs. Darwin Hinsdale, Mrs. Alton Marshall, Jacob Henkens, Jerry Jonas, Mrs. Robert Korns, Mrs. Wilbur Sperling, Walter Kinn, Frank Markus, Jr., and Mrs. Charles Filkins.

Pastor Scheibert instructs an Adult Bible Class.

<b>THURSDAY</b>	<p><b>GENUINE FRUIT CAKE NOW AVAILABLE</b></p> <p><input type="checkbox"/> 2 lb. Gen. Fruit Bar \$2.25</p> <p><b>NEW TWIN PACK</b></p> <p><input type="checkbox"/> Two 2 lb. Genuine Fruit Bars \$4.50</p> <p><input type="checkbox"/> 4 lb. Gen. Fruit Ring \$4.50</p>	<p><input type="checkbox"/> Cherry Cheese Cake ..... 69c</p> <p><input type="checkbox"/> Apple Nut Curls ..... 36c</p> <p><input type="checkbox"/> Strawberry Rhubarb Pie 69cc</p> <p><input type="checkbox"/> Fresh Orange Buns ..... 39c</p> <p><input type="checkbox"/> Mince Pie ..... 69c</p>
Oct. 13		
<b>FRIDAY</b>	<p><input type="checkbox"/> Home Style Baked Beans 29c</p> <p><input type="checkbox"/> Boston Brown Bread ..... 29c</p> <p><input type="checkbox"/> Glazed Donuts ..... 39c</p> <p><input type="checkbox"/> Oatmeal Cookies ..... 39c</p> <p><input type="checkbox"/> Unsalted Bread ..... 27c</p>	<p><input type="checkbox"/> ● Sunbeam Bread ..... 24c</p> <p><input type="checkbox"/> Chocolate Layer ..... 59c</p> <p><input type="checkbox"/> Biscuits ..... 29c</p> <p><input type="checkbox"/> ● Hard Seed Rolls ..... 25c</p> <p><input type="checkbox"/> Party Cups (16) ..... 59c</p>
Oct. 14		
<b>SATURDAY</b>	<p><input type="checkbox"/> ● <b>STRAWBERRY CREME LAYER</b> ..... 79c</p> <p><input type="checkbox"/> Danish Butter Coffee Cake ..... 59c</p> <p><input type="checkbox"/> Iced Angel Cake ..... 59c</p> <p><input type="checkbox"/> Pumpernickle Rye ..... 27c</p> <p><input type="checkbox"/> ● Crullers (plain or sugar) 24c</p>	<p><input type="checkbox"/> Pumpkin Pie ..... 69c</p> <p><input type="checkbox"/> ● Old Fashioned Bread 27c</p> <p><input type="checkbox"/> Orange Cups (9) ..... 49c</p> <p><input type="checkbox"/> Poppy Seed Bread ..... 27c</p> <p><input type="checkbox"/> Maple Walnut Loyer. .... 59c</p>
Oct. 15		
<b>MONDAY</b>	<p><input type="checkbox"/> California Cheese Cake 69c</p> <p><input type="checkbox"/> Sandwich Cookies ..... 39c</p> <p><input type="checkbox"/> ● Family Sandwich ..... 24c</p> <p><input type="checkbox"/> Chocolate Chiffon ..... 44c</p> <p><input type="checkbox"/> Cloverleaf Rolls ..... 33c</p>	<p><input type="checkbox"/> Unsalted Bread ..... 27c</p> <p><input type="checkbox"/> Red Raspberry Pie ..... 69c</p> <p><input type="checkbox"/> ● Cracked Wheat Bread ..... 27c</p> <p><input type="checkbox"/> Cinnamon Buns ..... 36c</p> <p><input type="checkbox"/> Gold Creme Cups ..... 32c</p>
Oct. 17		
<b>TUESDAY</b>	<p><input type="checkbox"/> Cherry Pie ..... 69c</p> <p><input type="checkbox"/> ● Whole Wheat Bread 27c</p> <p><input type="checkbox"/> Corn Sticks ..... 25c</p> <p><input type="checkbox"/> Cinnamon Raisin Bread 35c</p> <p><input type="checkbox"/> Pound Cake ..... 49c</p>	<p><input type="checkbox"/> Lite Diet ..... 30c</p> <p><input type="checkbox"/> Spice Sheet Cake ..... 49c</p> <p><input type="checkbox"/> Danish Ring ..... 49c</p> <p><input type="checkbox"/> ● Old Fashioned Crullers ..... 29c</p> <p><input type="checkbox"/> Canadian Oat Bread ..... 27c</p>
Oct. 18		
<b>WEDNESDAY</b>	<p><input type="checkbox"/> ● <b>VALENCIA RING</b> ..... 65c</p> <p><input type="checkbox"/> Apple Kuchen ..... 49c</p> <p><input type="checkbox"/> Date Muffins ..... 39c</p> <p><input type="checkbox"/> Sesame Seed Butter &amp; Egg Rolls ..... 33c</p> <p><input type="checkbox"/> Cinnamon Crullers ..... 25c</p>	<p><input type="checkbox"/> ● Apple Pie ..... 69c</p> <p><input type="checkbox"/> ● Butter Rolls ..... 29c</p> <p><input type="checkbox"/> ● Buffet Rye ..... 27c</p> <p><input type="checkbox"/> ● English Muffins (6) 25c</p> <p><input type="checkbox"/> ● Italian Bread ..... 22c</p>
Oct. 19		

# Freihofer's

• Indicates items available every day. The above is not a complete list of available items. For further information ask your routeman or call the bakery

**WATCH "FREDDIE FREIHOFFER"**  
**WRGB-TV WEEKDAYS**  
**5:45-6:00**





# Come to Church



## BETHLEHEM LUTHERAN CHURCH

Cor. Elm & Murray Aves.  
Rev. Harold W. Scheibert, Pastor  
Phones: HE 9-4328 & HE 9-2885

**SUNDAY:**  
8:30 Early Worship Service  
9:45 Sunday School and Adult Bible Class  
11:00 Worship Service

**CHRISTIAN SCIENCE SOCIETY**  
555 Delaware Avenue, Delmar, N. Y.

**SUNDAY — 11 A.M.**  
Church Service and Sunday School

**TESTIMONIAL MEETINGS**  
Every Wednesday at 8 P.M.

**READING ROOM:**  
397 Kenwood Ave.  
Hours: Tuesday-Friday, 11:30-3:30 P.M.  
Saturday 10:00-2:00 P.M.

## CLARKSVILLE COMMUNITY CHURCH

Rev. James A. Neevil, Pastor  
Sunday 9:45 a.m. Church School  
11:00 a.m. Service of Worship  
7:00 p.m. Youth Fellowship  
(All young people grades 7-12)

## COMMUNITY METHODIST CHURCH

Slingerlands - Rev. J. R. Rhodes  
Sunday  
11:00 A.M. Morning Worship, nursery and kindergarten care for small children  
9:45 and 11:00 Church School

## DELMAR PRESBYTERIAN CHURCH

Rev. George H. Phelps, Pastor  
Sunday services are held in the Delmar Masonic Temple, Kenwood Avenue & Adams Street  
Sunday  
10:15 Worship Service, Nursery and Church School, grades 1-6  
3:00 Jr. High course and fellowship (grades 7 and 8), 32 Albin Road, Delmar  
3:00 Sr. High and grade 9 course and fellowship, 4 Laurel Drive, Elsmere

Monday  
7:45 Choir rehearsal, 43 Union Ave., Slingerlands

## DELMAR REFORMED CHURCH

Delaware Avenue, Delmar  
Rev. Dr. LeRoy C. Brandt  
Thursday  
2 P.M. Women's Missionary Society  
7:30 P.M. Senior Choir rehearsal  
Friday  
7:30 P.M. Benevolent Program of Reformed Church in America, presented by the Rev. R. Mott Giles

Sunday  
9:45 A.M. Church School  
10 A.M. Arnold Adult Bible Class  
11 A.M. Worship Service, crib and nursery services

Tuesday  
3:45 P.M. Jr. Choir rehearsal

## FIRST METHODIST CHURCH

Kenwood Avenue, Delmar  
Rev. Arthur P. White  
Sunday  
9:30 and 11:00 Divine Worship  
9:30 Church School for Cradle Roll, Nursery, Kindergarten, Grades 1, 2, 3, 4, 5  
11:00 Church School for Cradle Roll, Nursery, Kindergarten, Grades 1, 2, 3, 4, 7, 8, 9  
4:00 Ninth Grade Fellowship  
5:00 Youth Choir rehearsal  
6:15 Youth Fellowship

## FIRST METHODIST CHURCH OF VOORHEESVILLE

New Scotland Road - Route 85  
Rev. Walter Taylor, Pastor  
Mr. and Mrs. Neldon Vandenburg, organist and choir director  
Mr. and Mrs. Gareld Kling, superintendents of Sunday School  
Sunday  
9:45 A.M. Sunday School  
11:00 A.M. Morning Worship

## FIRST REFORMED CHURCH of Bethlehem, Selkirk

**SUNDAY**  
9:45 A.M. Sunday School  
11:00 A.M. Worship Services  
7:00 P.M. Youth Fellowship  
**WEDNESDAY**  
6:45 P.M. Junior Choir  
7:30 P.M. Intermediate Choir  
8:15 P.M. Senior Choir

## GLENMONT COMMUNITY CHURCH (Reformed)

Weiser Street, Glenmont  
Rev. Harvey W. Noordsy  
HE 6-7710  
**SUNDAY:**  
10:00 Morning Worship  
Nursery care for young children  
11:10 a.m. Church School, classes for all ages, including adults  
7:00 Youth Fellowship

Thursday  
7:30 P.M. Midweek Program

## JERUSALEM REFORMED CHURCH

Feura Bush  
Robert Eggebeen, Pastor  
**SUNDAY:**  
9:30 a.m. Sunday School  
10:30 a.m. Worship Service  
6:30 p.m. Jr. Youth Fellowship  
7:45 p.m. Sr. Youth Fellowship

## NEW SALEM REFORMED CHURCH

New Scotland Road  
P.O. RD 1, Voorheesville  
Rev. William A. Boehne  
**SUNDAY**  
10 A.M. Sunday School  
11 A.M. Morning Worship  
**WEDNESDAY**  
7:30 P.M. Youth Fellowship  
**THURSDAY**  
3:30 P.M. Junior Choir rehearsal  
7:30 P.M. Senior Choir rehearsal

## NEW SCOTLAND PRESBYTERIAN CHURCH

Rev. Charles Rice, Stated Supply minister  
Sunday  
9:30 Sunday School  
11:00 Morning Worship —  
Monday  
7:30 Senior Choir  
Tuesday  
8 P.M. Evening Bible Study Group  
Wednesday  
11 A.M. Ladies Aid  
8 P.M. Men's Council  
Thursday  
10 A.M. Morning Bible Study Group

## NORMANSVILLE COMMUNITY CHURCH

C. Emory Weeks, Pastor  
**SUNDAY:**  
9:30 a.m. Sunday School, Children and Adults  
11 a.m. Worship Service  
7:30 p.m. Evening Fellowship Hour

**WEDNESDAY:**  
7:30 p.m. Hymn Sing followed by Adult Bible Class

**FRIDAY:**  
7:15 p.m. Youth Fellowship

**SATURDAY:**  
1 p.m. Choir practice  
8 p.m. Capital City Rescue Mission, 2nd week each month

## ONESQUETHAW REFORMED CHURCH

Tarrytown Road, off Route 32  
Robert Eggebeen, Pastor  
11 A.M. Sunday School  
12 Noon — Worship Service (Nursery service provided)  
Guild for Christian Service Meet-

ing — 3rd Tuesday of every month.  
Consistory Meeting — 3rd Wednesday of every month.

## ST. STEPHEN'S EPISCOPAL CHURCH

Elsmere Avenue, Delmar  
The Rev. Charles H. Kaulfuss, Rector  
The Rev. David Randles, Curate  
8:00 A.M. Holy Communion  
9:30 A.M. Holy Communion, Sunday School and Sermon  
11:00 A.M. Morning Prayer and Sermon

## ST. THOMAS CATHOLIC CHURCH

Delaware Avenue, Delmar  
Msgr. Raymond F. Rooney  
**SUNDAY MASSES** (in the Church) 7, 8, 9, 10, 11 (High Mass), 12. (In the Auditorium) 9, 10 and 12 noon.

**WEEKDAY MASSES:**  
6:45 and 7:30  
**SATURDAY MASSES:** 8 and 9

## THE METHODIST CHURCH

So. Bethlehem, Rev. W. L. Cosman  
**SUNDAYS —**  
9:45 a.m. Church School  
11 a.m. Morning Worship  
7 p.m. Youth Fellowship

## UNIONVILLE REFORMED CHURCH

Delaware Turnpike, Unionville  
Rev. Andrew Hansen, Pastor  
10:00 A.M. Sunday School  
11:00 A.M. Worship Service  
6:30 P.M. Youth Fellowship

## DELMAR PRESBYTERIAN CHURCH WOMEN TO SEE FILM ON KOREA

The Women's Association of the Delmar Presbyterian Church will meet at the home of Mrs. John Bourke, Delaware Avenue, Unionville, on Thursday, Oct. 13 at 8 P.M. The program will be a film, "An Epistle From the Koreans," the story of "In-Ho-Oh." Members are asked to bring Betty Crocker coupons and are reminded that a special offering for Medical Missions will be taken.

# ANNOUNCING

SATURDAY, OCT. 15, AT 10 AM  
the *OPENING* of  
a *NEW* and *BEAUTIFUL*

# ANTIQUER

SHOP -

# THE TOLL GATE

MRS. JERI SOMERS - Proprietress  
IN THE TOLLGATE PHARMACY  
BUILDING 1569 New Scotland Rd.

BOUGHT & SOLD

FREE PARKING HE 9-5514





# SPOTLIGHT CLASSIFIEDS

Classified Advertising  
**RATES**

10¢ per word for each insertion;  
\$1 minimum.

**CALL HE 9-4949**

Write, or stop in at our  
convenient office:  
154 Delaware Avenue

## AIR RAID SHELTERS

NUCLEAR shelter equipment and  
construction. K. F. Goeldner.  
HE 9-1436

## ASH & TRASH REMOVAL

ASH & trash removal; no charge  
for bundled newspapers. HE  
9-1287 Charles DeGrush.

## BARBECUES

CHICKEN barbecues — delicious  
— quantities of 25 or more! —  
Ideal for office, anniversary, etc.  
parties. Call for information. HE  
4-8903. John Geurtze, Prop.

## Bill DING Says

### OCTOBER SPECIAL!

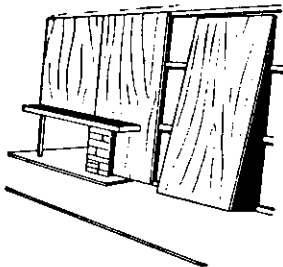

### V-GROOVED PANELS

4'x8'x1/2"

### PREFINISHED MAHOGANY

Reg. \$8.64 **\$5.76**  
Special

### UNFINISHED LIMBA

Reg. \$7.20 **\$6.20**  
Special

Open Saturday Till Noon

**Delmar**  
**LUMBER & BUILDERS' SUPPLY, INC.**

**HE. 9-9968** WE DELIVER

340 DELAWARE Ave. DELMAR, N.Y.

## BUSINESS OPPORTUNITY

LAUNDRY — all set up with  
equipment in Delmar — for sale  
or rent. HE 9-1416 HE 9-3047

## CARPENTRY

REMODELING — All types of  
carpenter work. H. A. Ertel,  
HE 9-1048. Ed. Hehre, HE  
9-1198

W. FLANSBURG — kitchen  
counter-tops, bath tile repair  
service. RO 5-2896

## DOLL REPAIRING

DOLLS repaired, restrung. Reina  
Deitz, 13 Ten Broeck St., Al-  
bany. HE 6-1690

## ELECTRICAL WORK

ALL TYPES electrical work. Call  
HE 9-4381

## FIREPLACE WOOD

FIREPLACE wood. Seasoned  
hardwood. Also kindling. HE  
9-2072

## FREEZE LOCKERS

BETHLEHEM Co-operative

Freeze Lockers. Same price as  
1945, 6 months \$9.00. Call  
HEmlock 9-3037 to apply. Good  
meat — convenience.

## FUNERAL DIRECTORS

In Time of Need, Call  
**M. W. TEBBUTT'S SONS**

176 State 12 Colvin  
Alb. HO 3-2179 Alb. IV 9-0116

420 Kenwood

Delmar HE 9-2212

11 Elm Street

Nassau 8-1231

Over 110 years of  
Distinguished Funeral Service

## FURNITURE REFINISHING

FURNITURE repairing, refinish-  
ing, re-upholstering. French, HE  
4-0633

## GRADING

GRADING, topsoil, fill & crushed  
stone. Backhoe available. Mi-  
chael Essex. HE 9-3702 — RO  
7-3478

## LAWN MOWERS

SHARPENED and repaired. Pick-

## THE SPOTLIGHT

up and delivery. Saws repaired.  
See our 1960 line of reel and  
rotary mowers. Trades accepted.  
Time payments. WACKSMAN,  
426 Third St., Albany. HO  
5-2756. Open evenings.

HAND and power mowers sharp-  
ened and repaired. Stored free  
for spring delivery. M. Gudz.  
HE 9-2025

## LAWNS & GARDENS

TRIMMING, fertilizing, landscap-  
ing. FREE estimates. HE  
9-2009. Greenleaf Gardens, 295  
Elsmere Ave., Delmar

TOP SOIL! We are now taking  
orders for the finest quality loam  
available. J. W. MICHAEL'S  
Co. Inc. HE 9-3823

## MASON WORK

BRICK, block, sidewalks, floors  
and chimneys. Free estimates.  
McKeon Construction. HE  
9-1294

## PAINTING — PAPERHANGING

ALL types decorating, painting,  
floors, ceilings, paper-hanging.  
HE 9-1436. Goeldner Contract-  
ing

ROY FLANSBURG, painting  
contractor. RO 5-2712. Voor-  
heesville, N. Y.

INTERIOR and exterior painting.  
Also carpentry work. Frank Sal-  
isbury. Days — HE 9-5527  
Nights — HE 9-1355

PAPER-HANGING, painting, in-  
terior and exterior decorating.  
Roofing and all general repair-  
ing. HO 3-2339

## ROOFING

CHIMNEYS, new roofs, gutters,  
repairing and painting. HO  
3-1604

## SAWS FILED

SAWS filed and set by hand or  
machine; also re-toothing. Plan-  
er knives sharpened. John Whit-  
ley Sr., 8 Vagele Lane, Glen-  
mont. HO 2-4154

## LEAVES REMOVED

from your lawn

fertilize NOW with Scotts TURF BUILDER

**ATTENTION!** WE WILL SPREAD ANY

LARGE BAG OF SCOTTS PRODUCTS

**\$1.** per bag plus price of product  
SPECIAL ONLY for 2 WEEKS

**GREENLEAF GARDENS** 295 ELSMERE AVE.,  
OPEN DAILY INCLUDING SUNDAY 8 AM to 9 PM • HE 9-2009

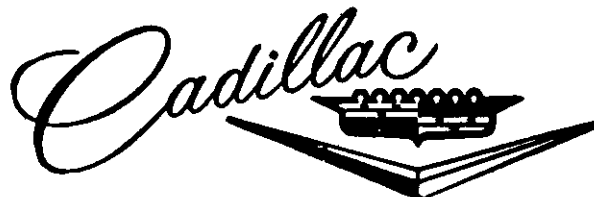

1958 CADILLAC  
4-Door

1958 OLDSMOBILE "98"  
Holiday Coupe

1957 CADILLAC  
4-Door Sedan

1957 CADILLAC  
Fleetwood Special

1957 CADILLAC  
El Dorado Seville

1959 BUICK  
Electra 2-Door Hardtop

1959 CADILLAC  
6 Window Sedan

1956 CADILLAC  
Limousine

THESE TO CHOOSE FROM—OPEN 9 TO 9

# John D. Wendell, Inc.

Albany County's Only Authorized Cadillac Dealer

450 CENTRAL AVE.

IV 9-4751

**FORDS**

'61 **FALCONS**

50 Models on Display  
FREE GIFTS!

**FORD**  
**Craigo**  
**MOTORS**

5 MINUTES FROM DOWNTOWN  
E. Greenbush GR 7-9302



**SCISSORS SHARPENED**

SCISSORS SHARPENED — factory method. 35¢. Called for and delivered. HE 9-3893

**SEPTIC TANK SERVICE**

NORMANSKILL Septic Tank Cleaners. 24 hour service. Ray Denney. HE 9-2824

**SEWING & ALTERATIONS**

ALTERATIONS and sewing. M. Buess. HE 9-1270

**SIGNS PAINTED**

SIGNS and posters hand painted to your specifications. Evenings and weekends — HE 9-5487

**TREE REMOVAL**

TREE removal. HE 9-3702 or RO 7-3478 Mike Essex.

**TRUCKING**

D. L. MOVERS. Furniture and appliance specialist. Every customer a satisfied one. HE 9-5210

**TYPEWRITERS REPAIRED**

TYPEWRITERS repaired and cleaned. Expert work guaranteed. HE 9-3461

**WESTINGHOUSE APPLIANCE SERVICE**

IMPERIAL Appliance Service Co. Factory trained service on WESTINGHOUSE ranges, dryers, washers, disposals, dish washers. William Dorato, formerly of Westinghouse Factory Service Co. Hours 8 to 5. HO 5-2035

**MERCHANDISE FOR SALE**

ALUMINUM combination windows, weather-stripped, triple track. \$16 installed. Taylor Aluminum Products. Robert Taylor, RO 5-2856

TROJAN runabout. Johnson 30 HP motor. Like new \$600. Frank Swartout, Ravenna 8-5071.

AWNING, 14 foot. New — with all fixtures. Color — red. Excellent condition. Roll-down type for store front. Reasonable. Call evenings HO 2-4713

1953 KELVINATOR electric range, full size 40". Perfect condition. PO 8-2626

GREEN nylon tulle, strapless floor-length formal — velvet trim. Size 14 \$25. HE 9-5318

SMALL mahogany console table, opens 3 leaves, seats 12, custom table pads included \$35. HE 9-4758

**BLACK TOP DRIVEWAYS**

Parking areas - Alley ways  
Sidewalks - Celler floors  
ALL WORK GUARANTEED  
J.M. HERRINGTON HO 5-8731

1956 ARISTOCRAFT 14 foot runabout with 1957 Mercury 40 h.p. motor and trailer \$695. ROger 7-3097

DOUBLE Provencal mahogany poster — excellent condition — complete sacrifice \$50. HE 4-7944

9 CUBIC foot freezer, girl's bicycle; child's victrola; mahogany bookcase. HE 9-1292

GREY Persian lamb coat. Size 12. Excellent condition \$25. HE 9-5128

13 CUBIC foot chest-type freezer. Call evenings HE 9-2580

MAGIC CHEF range — combination oil and bottled gas. Perfect, now in use. HE 4-7344 after 5 P.M.

FRIGIDAIRE electric stove, timer clock, deep well. Juke box for playroom. HE 9-4682

NORGE electric range. Reasonable. HE 9-2123

LIVING ROOM set, maroon and gray. Excellent condition. HE 9-1881

MOVIE camera, Bolex H-8, Pan Cinor Zoom lens, Revere 777 projector, Kodak precision enlarger, complete darkroom equipment — dryer, trays, etc. HE 9-9700

GARAGE doors, two, 4' x 8'. Excellent condition \$10. HE 9-4770

**PIANO BARGAINS**

There's a **HAMMOND ORGAN MODEL** For Every Purpose And Every Purse. 7 Styles and Many Finishes Prices Start at \$910

You may receive a brochure describing the various models in detail by phoning HO 2-5321 or writing:

CLUETT & SONS, EST. 1854  
35 Central Ave. HO 2-5321  
"Home of Hammond Organs"  
Open Thursday nights;  
any night by phoning before 5:30.

**AUTOMOTIVE FOR SALE**

1957 MERCURY commuter station-wagon, orchid and white, good condition, \$1050. Private owner. HE 9-4458

1959 SIMCA 4 door, completely equipped. Excellent condition \$1,150. IV 2-5843

1950 2 door CHEVROLET Club coupe, good running condition \$65. HE 9-2013

**HELP WANTED**

COMPANION - HOUSEKEEPER for single woman in a comfortable apartment. HE 9-2630 or HE 9-1723

**SITUATIONS WANTED**

BABY-SITTING afternoons and evenings 35¢ an hour. References. HE 9-4805

**WANTED**

COX Headliner machine — or similar. Call evenings. HO 2-4713

METRONOME wanted. Used but in good condition. HE 9-3081

WANTED — set of bongo drums. Good condition — reasonable. HE 9-2547 after 6 P.M.

**APARTMENT FOR RENT**

\$165 DRIFTWOOD Building — new, modern 3 bedroom. HE 9-5537

SMALL 2 bedroom apartment, Slingerlands. \$90. HE 9-2918

**HOUSE FOR RENT**

2 BEDROOM newly decorated. Stove, refrigerator, attached garage. Clarksville area. Adults preferred. Available after Nov. 1. 20 minutes from Delaware Plaza. \$100. PO 8-2374

**LOT FOR SALE**

2½ ACRES nice clear land Ravenna area, 482' road frontage \$950. HE 9-1107

**WHY PUT UP WITH  
NOW-YOU-HAVE-IT  
NOW-YOU-DON'T  
TYPE OF COMFORT?**

when you can buy a

*Republic*



**GAS HEATING SYSTEM**

and give your family

**C. H. C.**

CONTINUOUS HEAT CIRCULATION

JAMES D.

**WARREN & SON**

69 FOURTH AVENUE  
ALBANY o HE 4-6138

AN AUTHORIZED AUTOGAS DEALER

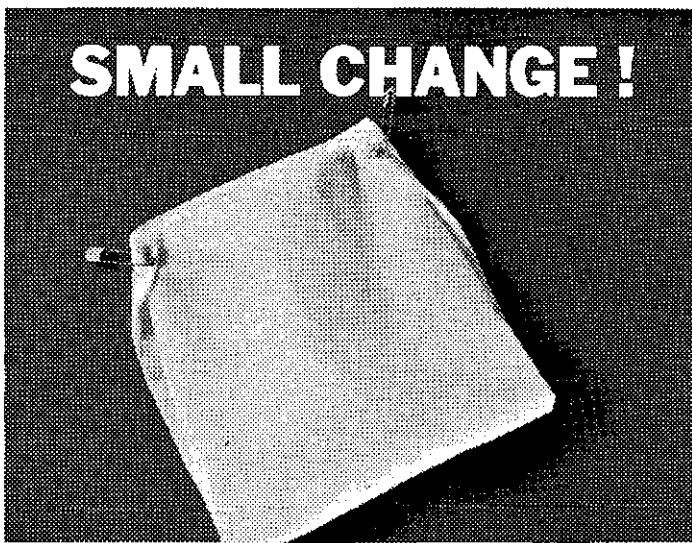

The electricity an automatic electric washer uses in five months costs about 60¢ . . . enough to buy a couple of diapers.

The cost of other items in your budget may have doubled in the last 20 years. But not Niagara Mohawk electricity. It's the biggest bargain you can buy!



BUSINESS MANAGED . . . TAXPAYING



**SAVE CASH & STAMPS**

during our  
**SENSATIONAL PRIZE WINNING**

**4-H**

**BABY BEEF SALE!**

**4-H**

TENDER - JUICY

- RIB STEAKS 79¢**
- SIRLOIN STEAKS 83¢**
- PORTERHOUSE STEAKS 89¢**
- CHUCK STEAKS 59¢**

**4-H**

- CHUCK ROAST 49¢**
- RIB ROAST (reg. style) 59¢**
- RIB ROAST (choice 1st 2 ribs) 75¢**
- BOTTOM ROUND ROAST 79¢**
- RIB ROAST (boneless cross) 79¢**

**FREEZER BUYS!**

- BEEF!** HIND-QUARTERS lb 59¢
- FORE-QUARTERS lb. 45¢

Above are all custom cut and wrapped for your freezer at no extra charge.

**DELAWARE PLAZA**  
**OPEN til 9P.M. MONDAY thru FRIDAY**  
 SATURDAY til 6P.M.  
 ● **PLENTY OF FREE PARKING** ●

**FREE** DURING OCTOBER ONLY  
**YOUR MOTOR CLEANED**  
 WITH COMPLETE  
 "FALL" CHANGE-OVER  
 or  
 COMPLETE TUNE-UP  
**BILL STEWART'S**  
**TRI-VILLAGE ESSO SERVICENTER**  
 309 Delaware Ave., Delmar, N.Y. Phone 9-4800

'EXPECT A MASTERPIECE'  
**UNUSUAL GIFTS...**  
**HOME DECORATIONS**  
**ATTRACTIVE PRICES**  
**DRIFTWOOD**  
 ARTS & CRAFTS INC.  
 750 DELAWARE AVE. DELMAR, NEW YORK HE 9-5537  
 Located in the REAR of the driftwood building.  
 Please use westside entrance  
**MANUFACTURERS • IMPORTERS • REPRESENTATIVES**

Permit No. 10  
**PAID**  
 U. S. POSTAGE  
 Bulk Rate

