

# The Spotlight

SEPTEMBER 20, 1973  
VOL. XVIII, NO. 37

Controlled Circulation Publication

20¢



# Budget Buys!

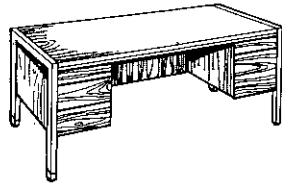

### EXECUTIVE DOUBLE PEDESTAL DESK

The exceptional design for the budget minded. This full 72" by 36" executive desk is in walnut finish with plastic laminate top with chrome trim. File drawers hold letter and legal size files.

Manufacturer's Price \$363.00  
**BUDGET PRICE \$270.20**

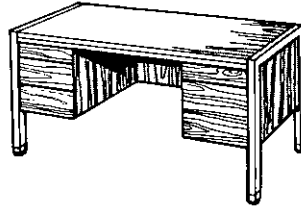

### DOUBLE PEDESTAL DESK

If our 72" executive desk is too large for your needs, try this 60" by 30" walnut finish executive desk. It features the same exceptional design with plastic laminate top with chrome trim.

Manufacturer's Price \$271.00  
**BUDGET PRICE \$205.60**

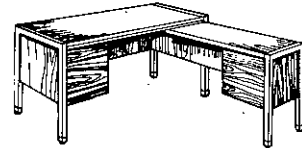

### SECRETARIAL "L" DESK

For the executive secretary. Consists of the executive left pedestal desk, 60" by 30" with the secretarial right return, 40" by 18". Also in walnut finish with plastic laminate top with chrome trim.

Manufacturer's Price \$389.00  
**BUDGET PRICE \$288.45**

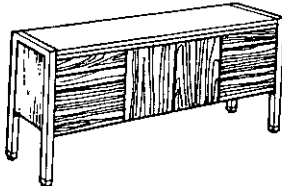

### EXECUTIVE CREDENZA

And last, to compliment the executive setting, we have this walnut finish credenza. Another exceptional design featuring 2 box drawers, 2 letter file drawers, and a 2 door center section with adjustable shelf. 66" wide x 18" deep x 28-1/2" high.

Manufacturer's Price \$311.00  
**BUDGET PRICE \$233.65**

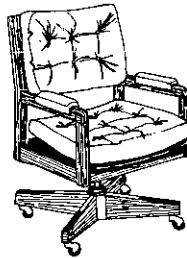

### SWIVEL CHAIR

Style and comfort team up in these chairs. Expensive-looking, but inexpensively priced, these chairs will add good looks to any office. Exposed wood has Walnut finish. Ideal for private offices and contract installations. Both chairs upholstered in Black Chame allover.

Manufacturer's Price \$138.75  
**BUDGET PRICE \$106.25**

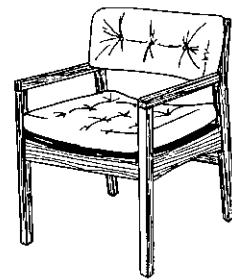

### ARM CHAIR

Manufacturer's Price \$90.90  
**BUDGET PRICE \$69.62**

**MARTIN UPTOWN**  
 750 CENTRAL AVENUE

750 CENTRAL AVENUE  
 ALBANY, N.Y.

489-1446

PHONE ORDERS ACCEPTED

FREE PARKING

CASH + CARRY

DELIVERY EXTRA

HOURS: MON.-FRI. 9-5:30 SAT. 10-4



Large National Health Insurance Organization needs sales oriented Executive to call on Business Accounts in the Tri-Cities Area . . . No insurance experience preferred. Contact Mr. Stanford - 438-4496.

**BASIL BOYEA**  
General Contractor  
KITCHENS • BATHROOMS  
ADDITIONS • REMODELING  
Free estimates • 439-2854

*There is only one child  
like yours and only  
one photographer like  
John Collins, 434-8234*

The deadline for Spotlight Classified Ads is Friday afternoon preceding publication the following Thursday.

## THIS IS YORKTOWNE STONEWARE.

It is:

- Oven Proof
- Dishwasher Safe
- Amazingly Durable
- Handsome • Inexpensive
- We carry nearly everything in stock

And we have a great special for you:

5 Piece PLACE SETTING

Year 'round price: \$8.00

**SPECIAL 4.50**

Includes: Dinner, Salad, Cereal, Cup, Saucer.

We also carry these in stock:

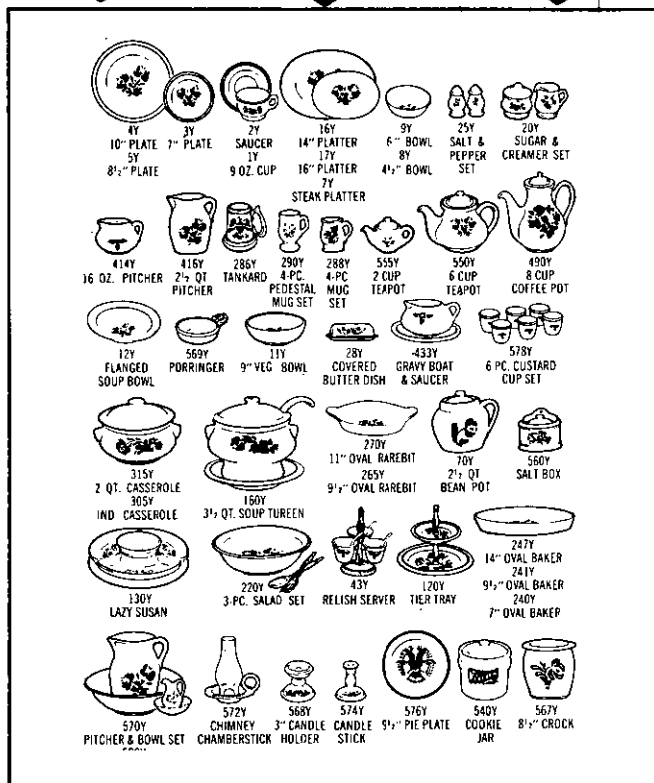

## THIS IS HERITAGE STONEWARE

IT IS EVERYTHING  
THAT YORKTOWNE IS.  
PLUS A SPECIAL TOO.

5 Piece PLACE SETTING

Year 'round price: \$7.10

**SPECIAL 3.95**

Includes: Dinner, Salad, Cereal, Cup, Saucer.

We also carry these in stock:

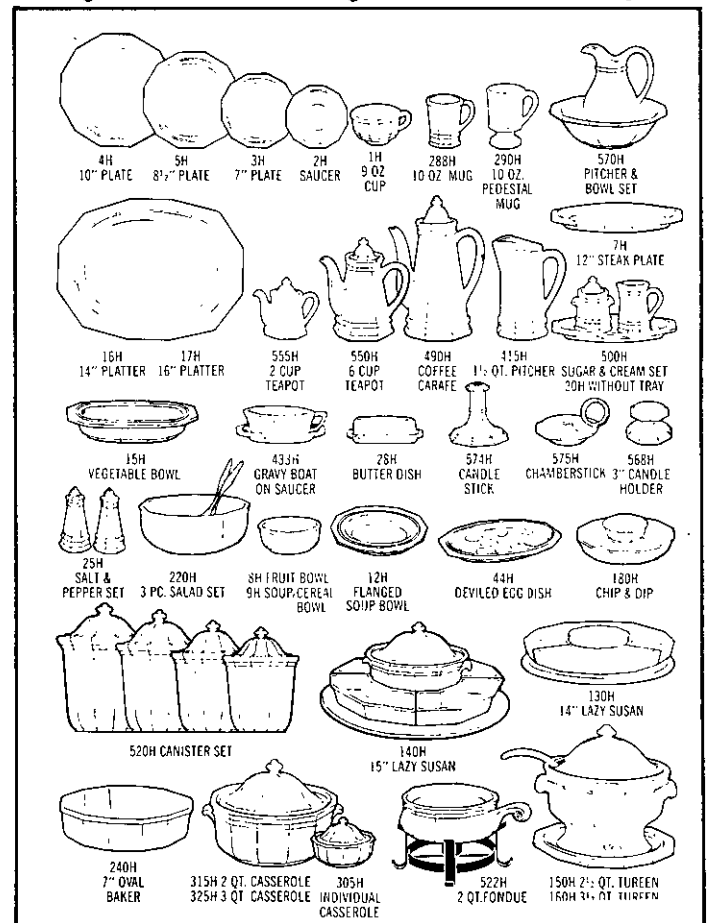

**The Village Shop**

DELAWARE PLAZA, DELMAR

# national auto



**SPECIAL SAVINGS**  
for ENTIRE FAMILY  
HOME • OFFICE  
SHOP and AUTO

**38**  
STORES  
SERVING  
NEW YORK

# OLD FASHION COUPON Savings Sale

**SPECIAL OFFERS AT UNBEATABLE PRICES!**

**FREE STUDS**  
a 9.96 VALUE!  
WITH EACH PAIR OF  
**RETREAD TIRES**

**FREE STUDS!**

**CORDOVAN RETREAD SNOW TIRES**  
BLACKWALL TUBELESS

**15 MONTH or 15,000 MILE GUARANTEE**

**13<sup>97</sup>** Each 600-13

**CHARGE EM'**

SIZE	PRICE
650-13	14.97*
E78-14	15.97*
F78-14	16.97*
G78-14	17.97*
H78-14	18.97*
G78-15	17.97*
H78-15	18.97*
560-15	15.97*

Plus F.E. Tax 36¢ to 56¢ Each

with coupon

<p>SPARK PLUG WRENCH REG. 39¢</p> <p><b>28¢</b></p> <p>with coupon</p>	<p>Heavy Duty MOTOR OIL REG. 56¢</p> <p><b>37¢</b></p> <p>with coupon</p>	<p>1 Gal. WINDSHIELD CLEANER REG. 88¢</p> <p><b>59¢</b></p> <p>with coupon</p>	<p>SYLVANIA HOUSE BULBS Reg. 4/1.16</p> <p><b>4 for 77¢</b></p> <p>with coupon</p>	<p>PROPANE TORCH REFILL REG. 1.29</p> <p><b>88¢</b></p> <p>with coupon</p>	<p>FAN BELTS REG. 1.69</p> <p><b>99¢</b></p> <p>with coupon</p>
--	---	--	--	--	---

**Check anywhere... You'll always Save More at NATIONAL AUTO**

<p>CORN BROOM REG. 1.69</p> <p>Save 60¢</p> <p><b>1<sup>09</sup></b></p> <p>with coupon</p>	<p>SAVE to \$1.</p> <p>IGNITION TUNE UP KIT REG. to 2.99</p> <p>Save UP TO \$1.00</p> <p><b>1<sup>99</sup></b></p> <p>with coupon</p>	<p>PUROLATOR OIL FILTER REG. 2.88</p> <p>Save 89¢</p> <p><b>1<sup>99</sup></b></p> <p>with coupon</p>	<p>SAVE 1.08</p> <p>FURNACE FILTERS most sizes Reg. 6/3.42</p> <p>6 for <b>2<sup>34</sup></b></p> <p>with coupon</p>	<p>TOILET SEATS REG. 3.59</p> <p>Save 1.10</p> <p><b>2<sup>49</sup></b></p> <p>with coupon</p>
<p>THERMO WEAVE BLANKET REG. 4.95</p> <p><b>2<sup>95</sup></b></p> <p>SAVE 2.00</p>	<p>RAC AUTO TIMING LIGHT REG. 3.98</p> <p><b>2<sup>99</sup></b></p> <p>Save 99¢</p>	<p>Aluminum ACORDIAN DRYER REG. 4.95</p> <p><b>3<sup>97</sup></b></p> <p>Save 98¢</p>	<p>9'x12' LINOLEUM RUGS REG. 5.97</p> <p><b>4<sup>97</sup></b></p> <p>Save \$1</p>	<p>MAGIC MAID 2 SLICE TOASTER REG. 8.87</p> <p><b>6<sup>99</sup></b></p> <p>Save 1.88</p>

**SALE ENDS SATURDAY**

TOWN SQUIRE SHOPPING PLAZA, GLENMONT, ROUTES 9W & 32

Open Monday thru Saturday 9 A.M. to 9 P.M.



Use national auto **CREDIT PLAN**

# Spotlight CALENDAR

## ABOUT THE CALENDAR

The information printed in this column is a FREE service to **Spotlight** readers. We neither charge nor receive any fee for publicizing these events. It is for this reason that we ask those who send in information to make sure that it is complete; we **cannot** (repeat: **CANNOT**) make weekly changes in running announcements.

Because the Calendar condenses the coming event in capsule form, it has become one of the most widely-read weekly **Spotlight** features. It was so designed to allow for more space for additional features. Therefore, organizations should **not** expect to find a duplication of facts in another place. If we were to run all of the events **twice**, we'd be cutting down on our available space and thereby defeat the whole concept.

**Rotary Club** of Delmar meets every Tuesday night at 6:15 at Schrafft's.

**Give and Take Shop**, staffed and stocked by residents of Delmar, clothing for all occasions, all ages, all sizes, available to everyone. Basement St. Thomas Apostle Church & Rectory, Mon. 9:30-11:30 A.M., Tues. 1-3 P.M., Sat. 10 A.M.-12 Noon.

**Every Thursday** at 7 P.M., Delmar Reformed Church, scout meeting for handicapped, Troop 159.

**Kiwanis Club** of Delmar meets every Monday night at 6:15 at The Center Inn, Route 9W, Glenmont.

**Bethlehem Lions Club** meets 1st and 3rd Wednesdays of the month at The Center Inn, Route 9W, Glenmont, 6:30 P.M.

**AARP meets** 1:30 P.M., third Tuesday of month, Delmar First United Methodist Church, Kenwood Avenue, Delmar.

**Tri-Village Nursery School** fall registration open to 3-5 year olds. Information: Maureen Manzella, 439-9295; Susan Ayers, 439-4757.

**Career Source Center**, BCHS, open every Tuesday, 7:30-9:30 P.M.

**The Delmar Community Orchestra** rehearses every Monday evening from 8 to 10 at the First United Methodist Church of Delmar.

**Through September 27** — Free nature movies every Tuesday and Thursday nights at the Outdoor Amphitheater, Five Rivers Environmental Education Center, Delmar. Occasional trailwalks at 7 P.M. Pick up a schedule of evening activities at the Center.

**Registration now being accepted for the fall afternoon classes for 4 year olds at the LEA Nursery School.** For further information please call Mrs. Boykin at 463-0512 or after 5:30 P.M. Mrs. Denison, at 439-4019.

**Clam Chowder** on sale at the New Salem Reformed Church the 3rd Friday of each month, through September. Address — Route 85, New Salem, hours 12 noon to 4 P.M. Bring own containers.

**Trap Shooting**, Bethlehem Sportsmen's Club, Dunbar Hollow Road, Clarksville, every Wednesday, 7 to 10 P.M., Sunday 1 to 4 P.M. Non-members welcome. NRA awards available. Directions: 439-4223.

**Current exhibit** at Bethlehem Historical Association, Route 144, Cedar Hill: "Old time quilts and stitchery for new time living." See Bethlehem Star, Crazy Quilt, Log Cabin and others between 2 and 5 any Sunday afternoon. A wealth of ideas for people interested in reviewing these arts.

**Bethlehem Jaycees** meet second and fourth Wednesdays of the month, 8 P.M., Center Inn, 9W, Glenmont.

**Creative Play Pre-School** of First Reformed Church of Bethlehem opens September 10. Registration information: Kathryn Piihofer, 767-9551.

**Chinese Language Classes** — ages 5 through 17 may enroll in classes sponsored by the Chinese Community. Session: September 22 to December 15. Classes held at Loudonville Community Church, Saturday, 9:30-11:30 A.M. Info: Dr. Shen, 439-2362.

**Rosary** — St. Thomas Church, Adams Place, Delmar, every Thursday at 11:45 A.M.

**Career Resource Center** in Guidance Office at BCHS, open Thursdays 7-9 P.M. Community residents may use facility.

**To Oct. 1**, exhibit gravestone rubbings, Bethlehem Public Library, by Mrs. Claire Loux, Rev. Dr. Joseph Loux, Jr., Mrs. Marjorie Loux. Taken from stones in N.Y., Mass., Vt., they date from 1600s.

## THURSDAY, SEPTEMBER 20

### BCHS Sports

Varsity Golf, Shaker at Beth., 3:45 P.M.

**6:30 P.M., meeting**, Albany County League of Women Voters, McKownville Methodist Church. Topic: Albany County Charter.

## SATURDAY, SEPTEMBER 22

**All day today** and tomorrow, open house, Rakowana Archers, Picard Rd., Altamont. Fall tournament, all archers invited, refreshments.

**4-8 P.M., Annual Chicken Bar-B-Q**, New Scotland Kiwanis Club at New Scotland Presbyterian Church. Adults, \$3.25; children under 10, \$1.75. Take-out: 439-6465 after 4 P.M.

**10 A.M., National Hunting and Fishing Day** celebration, Bethlehem Sportsmen's Club, Cass Hill Road, west of Clarksville. Day-long shooting and archery contests for youngsters. Bring lunch or buy it at the club. Demonstrations in afternoon, pie eating contest, log rolling — all for fun!

**10 A.M.-4 P.M.**, open house, Five Rivers Environmental Education Center. Demonstrations at 10, 11 A.M., 1 and 2 P.M. Nature walks at 11 A.M., 2 and 3 P.M.

**4:30 P.M. on**, family style turkey dinner, Helderberg Chapter #331, Masonic Temple, Altamont. Adults, \$4; children under 12, \$1.50.

## MONDAY, SEPTEMBER 24

**8 P.M., Western Square** dance lessons, Helderberg Twirlers, Guild-erland Middle School.

## TUESDAY, SEPTEMBER 25

**12 Noon**, Meet the Candidates Luncheon, Town of Bethlehem Women's Republican Club, at Nor-

## FALL PLANT SAVINGS

Better plants and fall savings are a perfect combination for fall planting time.

# SAVE 10-20%

- EVERGREENS
- SHADE TREES
- SHRUBS

HOURS: Daily 'til 6, Sun. 10 to 4

The  
**Garden Shoppe**

NURSERY — GARDEN CENTER  
Feura Bush Rd., Glenmont  
439-1835

SOME PLANTS —  
50% OFF

**WHO?** The YWCA of Albany  
55 Steuben Street  
Brings to you the

**WHAT?** "YW Wives" Program  
A unique morning out with baby sitting provided. Choice of Yoga or Slimnastics, including knitting, crocheting, alterations & hemstitching, topped off with a "Cooking with a Flair" lunch!

**WHERE?** Bethlehem Lutheran Church  
85 Elm Avenue, Delmar (on the bend)

**WHEN?** Wednesday 9:30-1 p.m. starting October 3.

**WHY?** Because YOU asked for it!

Call  449-7184 — Register NOW!

# PILOTS WANTED

or rather serious-minded men & women & young adults interested in learning to fly.

Professional instruction adjusted to your learning rate.

For information on complete or solo courses phone 899-9593 or 439-7707 or drop by the

## ROUND LAKE AIRPORT

ROUND LAKE, N.Y.

**\$5.00 introductory flight available at all times.**

manside Country Club. Everyone invited. Reservations: Barbara Silber, 439-3639.

**8 P.M., meeting,** Slingerlands Homeowners Association, Community Room, The Bank, 343 Delaware Ave., Delmar. Dr. Edward H. Sargent, Jr., guest speaker.

**8:15 P.M., meeting,** La Leche League, home of Mrs. Paul Donnelly, 33 Fairway, Delmar.

**8 P.M., meeting,** Parent Faculty Organization, BCHS cafeteria. Parents will meet Charles Gunner, new principal, Dr. J. Briggs Andrews, new Assistant Superintendent, and Dr. Clarence Spane, new psychologist.

**8 P.M., community house,** Delmar Camera Club, St. Stephen's Episcopal Church. Exhibit of black and white prints and color slides. All welcome.

### THURSDAY, SEPTEMBER 27

**8 P.M., meeting,** Albany County Audubon Society at Five Rivers Environmental Education Center.

### SATURDAY, SEPTEMBER 29

**Happy Birthday, Susie!**

**10 A.M.-5 P.M.,** Village Mart, Bethlehem Lutheran Church, 85 Elm Avenue, Delmar. Games, home baked goods, crafts, treasure chest, tog shoppe, claypot, Le Petit Gallerie, lunch available, auction.

### WEDNESDAY, OCTOBER 3

**8:00 P.M.** The Town Board of Appeals will hold a public hearing tonight at the Town Offices, 393 Delaware Avenue, Delmar, N.Y. on application of Dennis T. Hurley, 257 Ontario St., Albany, N.Y. for a Special Exception from Article V of the Town Zoning Ordinance to permit construction of a four-unit dwelling at 576 Delaware Ave., Delmar, N.Y.

Your host: E.V.F. Co.

In case the abbreviation floors you, it means: The Elsmere Volunteer Fire Company! The members of the company will be hosts on SEPTEMBER 25—7:30 P.M.

at three locations:

ELSMERE ELEMENTARY SCHOOL  
COLONIAL ACRES (Feura Bush Rd.)  
KENHOLM POOL

The members of the group would like to meet the residents of the Elsmere Fire District. There will also be demonstrations at all three locations simultaneously.

## CHURCH DIRECTORY

### FIRST REFORMED CHURCH OF BETHLEHEM

Route 9W, Selkirk

Parsonage & Study Phone  
— 767-3406

Office Phone — 767-2243

Staff

Jack Hilbrands, B.D. . . . . Pastor

Vernon O. Nagel, B.D. . . . . Minister of Calling

Mrs. Marlin Fuller . . . . . Organist & Choir Director

Mrs. Peter VanKampen . . . . . Church School Superintendent

### Sunday Schedule

9:30 A.M. — Sunday School

11:00 A.M. — Worship Service

7:00 P.M. — Youth Fellowship

### GLENMONT COMMUNITY CHURCH (Reformed)

3 Weiser St., Glenmont

Rev. Jack Cooper, Pastor

10 A.M. — Worship Service

11:15 A.M. — Sunday School

Everyone Welcome

("Coffee and . . ." after service)

### FIRST CHURCH OF CHRIST, SCIENTIST

555 Delaware Ave., Delmar  
439-2512

Sunday Services at 11 A.M.

Sunday School also at 11 A.M. for those under the age of 20

Wed. Testimony Meetings 8 P.M.

Reading Room at

397 Kenwood Avenue

Daily except Sun. and holidays

11:30-4:00

Everyone Welcome!

### DELMAR REFORMED CHURCH (founded 1841)

386 Delaware Ave., Delmar, N.Y.

Worship & Church School 10 A.M.

Nursery Care . . . . . 10 to 11 A.M.

Coffee Fellowship . . . . . 11 A.M.

Church School

dismisses . . . . . 11:30 A.M.

Youth Groups . . . . . 6:30 P.M.

Pastors: Gerard J. Van Heest,

David L. Cooper

Pastor Emeritus: LeRoy C. Brandt

Minister of Music — Jos. R. Gerber

Everyone Welcome

# State Bank of Albany offers you 8% interest on its 170th. Birthday.

Now, and for a limited time during the celebration of our 170th year, we are offering the highest rate of return on your money anywhere in the region. A four-year, 8% Savings Certificate is offered with interest paid quarterly to those of our depositors

who have a like amount in a Savings or Investment Passbook Account. Minimum amount for Certificate is \$2,500, maximum \$5,000. We have also increased interest rates on all other State Bank Savings Plans. See how much money your savings can earn with one of the savings plans available now from any office of State Bank of Albany.

Passbook Accounts	Annual Yield	
5% Savings Passbook*	5.09%	
5.5% Investment Passbook*	5.61%	
Savings Certificates	Annual Yield	Value at Maturity
6.0% guaranteed 1 year	6.14%	\$5,000 grows to \$5,307
6.0% guaranteed 1 year	6.14%	\$2,000 grows to \$2,122.80
6.0% guaranteed 1 year	6.14%	\$1,500 grows to \$1,592.70
6.0% guaranteed 1 year	6.14%	\$1,000 grows to \$1,061.40
6.5% guaranteed 2½ years	6.66%	\$5,000 grows to \$5,874.55
6.5% guaranteed 2½ years	6.66%	\$2,000 grows to \$2,350
6.5% guaranteed 2½ years	6.66%	\$1,500 grows to \$1,762.50
6.5% guaranteed 2½ years	6.66%	\$1,000 grows to \$1,174.91

8% certificates in \$2,500 denominations pay an annual yield of \$200 each, interest paid to you quarterly. At maturity you will have received a total of \$800 interest for each certificate.



Member since 1973 - Corporation of New York

**If you want to  
borrow money,  
We want to lend it.**

Early withdrawals from Savings Certificates permitted. Federal regulations now permit early withdrawal from savings certificates for any reason whatsoever. However, *only the funds withdrawn* we are required to adjust the interest to the regular passbook rate for the entire time the funds have been on deposit and to eliminate interest entirely for the last 90 days before the withdrawal.

\*Savings Passbook and Investment Passbook increased interest rates are effective beginning October 1, 1973.



# WEO

WHERE ECONOMY ORIGINATES

# Weeeeeee!

**IMPORTANT FOR YOU**

**A & P POLICY:** Always do what is honest and fair for every customer.  
**RAINCHECK:** If an advertised special is ever sold out ask the Manager for a Raincheck. It entitles you to the same item at

the same price the following week. Or if you wish we'll give you a comparable item at the same special price.  
**GUARANTEE:** A&P offers an unconditional money-back guarantee. No matter what it is, no matter who makes it, if A&P sells it A&P guarantees it.

CHECK & COMPARE!

SLICED <b>Allgood Bacon</b> "SUPER-RIGHT" REGULAR	1 LB. PKG.	\$129
<b>Frankfurters</b> "SUPER-RIGHT"	1 LB. PKG.	\$109
<b>Pork Ribs</b> "SUPER-RIGHT" QUALITY BEEF RIB END	LB.	\$119
<b>Top Round Steak</b> "SUPER-RIGHT" QUALITY BEEF	LB.	\$198
DELICIOUS FRESH <b>Steaked Cod</b>	LB.	89¢

"SUPER-RIGHT" QUALITY BEEF

## STEAKS

- SIRLOIN BONE IN OR
- BONELESS SHOULDER

**YOUR CHOICE!**

BONE IN  
**Porterhouse**  
CUT FROM CHUCK  
**Cubed Steak**

\$ **168**  
LB.

LB. \$188  
LB. \$178

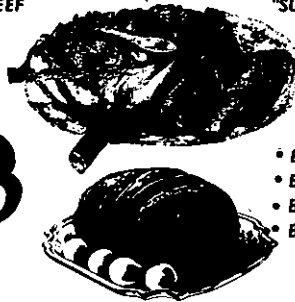

"SUPER-RIGHT" QUALITY BEEF

## ROASTS

- BONELESS BOTTOM ROUND
- BONELESS TOP ROUND
- BONELESS BACK RUMP
- BONELESS TOP SIRLOIN

**YOUR CHOICE!**

\$ **169**  
LB.

U.S. GOVT. INSPECTED

### Box-O-Chicken

- 3 BREAST QUARTERS with wings
- 3 LEG QUARTERS with backs
- 3 NECKS
- 3 WINGS
- 3 GIBLETS

LB. **55¢**

"SUPER-RIGHT" FULLY COOKED

### Smoked Ham

WATER ADDED

SHANK  
HALF  
LB.

**88¢**



### Kleenex

200 - 2 PLY FACIAL TISSUE

3 \$ **100**  
PKGS.



### Towels

KLEENEX BOUTIQUE

3 \$ **100**  
JUMBO ROLLS



### Napkins

KLEENEX 140 IN PKG.

3 \$ **100**  
FOR

**Weeeeeee!**

PORCELAIN FINE CHINA

**BONUS VALUE THIS WEEK!**

BREAD AND BUTTER PLATES

**39¢**

each with every \$5 grocery purchase. No Limit



4 SALAD PLATES

\$ **489**

No purchase required. No Limit

### Green Peppers



LB. **39¢**

### Bartlett Pears



LB. **29¢**

### Green Cabbage



LB. **10¢**

### McIntosh Apples

U. S. No. 1, 2 1/2" MIN. & UP

3 LB. BAG **49¢**

### Anti-Freeze

MARVEL PERMANENT TYPE



GAL. **\$139**

### Fresh Orange Juice

KRAFT'S

1/2 GAL. BTL.

**69¢**

Price effective thru Sat., Sept. 22, 1973. Items for sale not available to other retail dealers or wholesalers. Not responsible for typographical errors.



**BETHLEHEM LUTHERAN CHURCH**

85 Elm Ave., Delmar

Rev. Paul H. Gassman

9:15 A.M. Sunday School and Bible Classes

10:00 A.M. Coffee Hour

10:30 A.M. WORSHIP SERVICE (Nursery Care)

1st & 3rd Sundays — Communion

**Thursday Evening Services**

Three area churches are featuring a 7:15 Thursday evening service during July, August and September. Each service will feature a guest speaker, musical and singing groups. During July, the services will be held on the lawn of the Reformed Church in Feura Bush; August: on the lawn of the Church in Onesquethaw; September: lawn of the New Salem Church.

Come as you are! Bring a chair or blanket!

**FIRST UNITED METHODIST CHURCH**

428 Kenwood Avenue, Delmar  
Phone 439-9976

Worship Service: 9:15 & 11 A.M., Sunday  
(Nursery and Child care provided)

Coffee Fellowship at 10:15

Church School: 9:15 & 11, Sunday  
4:00 P.M., Tues. (Grades 1-5)

Sr. U.M.Y.F. 6:15 P.M., Sunday

Pastor: Robert B. Thomas  
Thomas D. Peterson, Sang Hahn

**LIBRARY NOTES**

The Bethlehem Public Library announces its winter hours. These will be in effect through the middle of June, 1974.

Mon.-Fri.: 9 A.M.-9 P.M.

Saturday: 10 A.M.-5 P.M.

Sunday: 1 P.M.-5 P.M.

There is a parking lot behind the Library; it is entered from Borthwick Avenue.

For returning books when the Library is closed, there is a book deposit on the back of the building near the garage door. Please don't return films or records there though, as they are apt to be damaged.

**The Spotlight Goes to School**

**Continuing Education**

Continuing Education courses sponsored by the Bethlehem Central School District will begin next week, Monday, Sept. 24. Persons may register by calling John Falvey at 439-2410, or by attending the first session of a class.

The fee for each 10-week course is \$10, except for Driver Education which costs \$30.

All classes listed here, with the exception of Beginning Swimming, will be conducted from 7:30 to 9:30 P.M.

Here is a schedule of the courses to be offered for the fall semester.

**Mondays:** Middle School — Driver Education, Beginning Swimming, (7 to 8:20 p.m.) Bookkeeping for the Housewife, Sewing with the New Knits, Interior Decorating, Conversational Italian; High School — Auto Mechanics, Beginning Dressmaking.

**Tuesdays:** Middle School — Investments, Stenoscrypt, Beginning Typing, Creative Stitchery, Rya, Sketching and Drawing, Reupholstering; High School — Oil Painting, Beginning Dressmaking.

**Wednesdays:** Middle School — Interior Design, Beginners' Art, Advanced Art, Parent and Child Relationships, Nutrition and Food Management, Creative Intelligence; High School — Photography.

**Volunteer Program**

Even though the Bethlehem Central School Volunteer Program has more participants than ever before, newcomers are always welcome and can lend their talents to pupils and staff in a wide variety of ways.

According to Mrs. Joyce Strand, School Volunteer Chairman, orientation meetings for volunteers will soon be held at all district schools. For more information and for meeting dates, persons interested may call the following individual school chairmen:

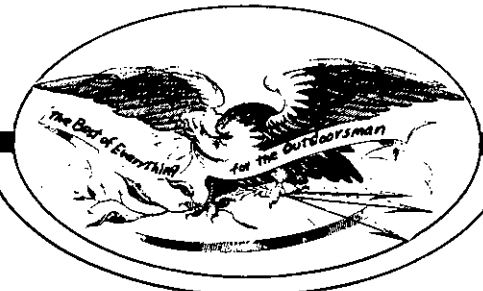

**PENDLETON — THE PACE MAKER**

Lady Pendleton sets the pace this fall with a selection of new coordinates in autumn colors to complete your wardrobe. This solid-tone vest and blouse are picked up in a color coordinated multi-colored hounds tooth check jacket and slacks. Shown: In all wool . . .

Jacket, \$65;  
Vest, \$36;  
Slacks, \$30;  
Blouse of 100% nylon, \$18.50.  
Sizes 8-18.

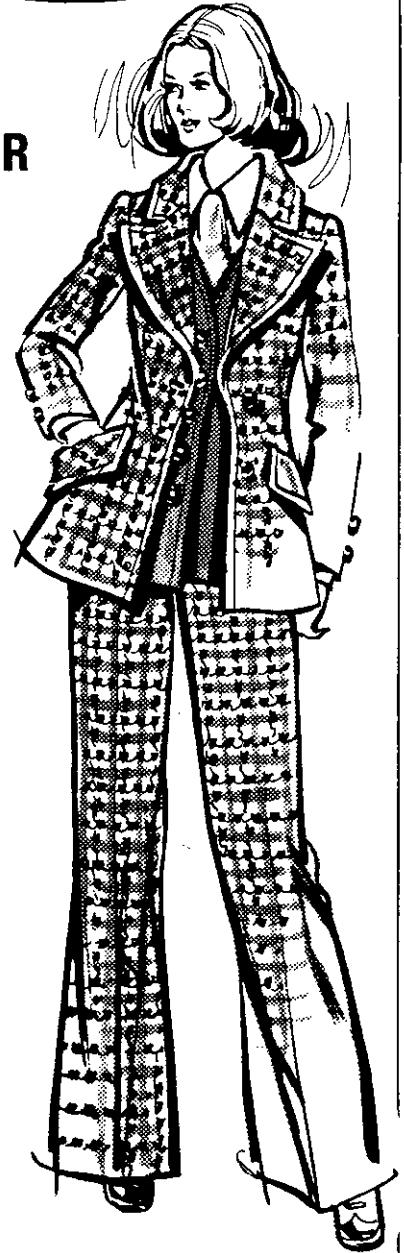

Shop Daily 9 to 9  
Saturdays — 9 to 5

**MOORE'S TRADING POST**

ROUTE 9W, RAVENA, NEW YORK 12143

## TENNIS RACKETS

Restrung — Regripped

## VIOLINS REPAIRED

Bows Reaired

USED STUDENTS VIOLINS & 1 VIOLA  
C.M. LACY 3 Becker Terrace  
439-9739

**DON'T  
CUT OFF  
CHILDREN'S LIVES**

**DO  
DRIVE  
CAREFULLY**

# Because we take care of our cars when we rent them, they're in good shape when we sell them.

## 1973 CHEVROLETS

Impala 4 dr. H/T

Monte Carlo

Landau Coupes

Factory A/C

Power Brakes,

Power Steering,

Radio, Heater,

Defroster

## 1973 FORDS

LTD 4 dr. H/T

Grand Torino

Brougham 2 dr. H/T

Factory A/C

Power Brakes,

Power Steering,

Radio, Heater,

Defroster

© HERTZ SYSTEM, INC., 1977

At Hertz we buy new cars every year.

So we always have last year's models to sell. Chevrolets that are just one year old or less. Our stock includes a wide choice of sedans, hard-tops.

And our cars have been washed, serviced and checked out after they have been driven.

In fact, the used car you buy from us was probably better taken care of than any car you've owned yourself.

1 Year or 12,000 mile power  
train warranty (from Fleet Aid Corp.)

**Hertz not-so-used cars.**

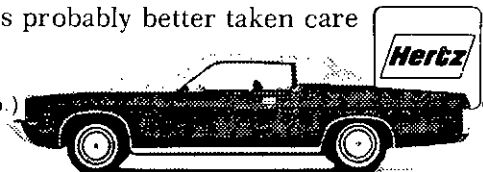

# KNICKERBOCKER DRIVURSELF, INC.

HERTZ SYSTEM MEMBER • P.O. Box 5249, 16 Brown Road (off Fuller Road), Albany  
N.Y. 12205 • Telephone: 518 459-8090 Open 9-5 Mon. thru Fri., 10-4 Saturday

**FIRST SHOWINGS FRIDAY, SEPTEMBER 21st**

Clarksville, Mrs. Harry Stannard; Delmar, Mrs. William Seyler; Elsmere, Mrs. Louis Brickman or Mrs. Louis Choppy; Glenmont, Mrs. Harold Kelp; Hamagrael, Mrs. Robert Wensley; Slingerlands, Mrs. Robert Van Aernem; Middle School, Mrs. Robert Foresman, Mrs. Charles Guinn, or Mrs. Charles Pitt; and High School, Mrs. E. B. Stringham.

### Three New Teachers

The Business Education Department at Bethlehem Central High School has three new members this year, Merle E. Miller, Chairman of the Department, announced this week.

With the resignation of Hugh J. Brown from the High School staff, Mrs. Barbara D. Linford was appointed to teach consumer education and distributive education. Mrs. Linford is a graduate of Utah State University, and she has taught in Utah and Ohio before moving to Albany last February. She has three children who attend the Guilderland Central School, while her husband is busy with the Automation of the library at SUNY at Albany.

Mrs. Sue Ralston of Ravena, is teaching part time because of added enrollment in the High School business department. She will teach book-keeping, personal typing and business law. Mrs. Ralston is a graduate of Montclair State College, Montclair, New Jersey and has her Master's degree from SUNY at Albany. Her two children attend Ravena-Coeymans Central School where her husband is a business teacher and head football coach. Mrs. Ralston and her husband are co-owners of Hannacroix Paso Finus stables, Caribbean-area gaited horses.

At the Middle School, Mrs. Eleanor Tomiko has been appointed to the vacancy occasioned by the retirement of Mrs. Doris Stephany. Mrs. Tomiko is a graduate of SUNY at Albany where she was a member of Pi Omega Pi, the honorary Business Education

Fraternity. Mrs. Tomiko has had wide experience in business, and decided to enter education as her family was leaving school.

### Shorthand Awards

On the first day of classes at Bethlehem Central High School, awards earned in May and June were distributed by Mrs. Margaret H. Westervelt to returning shorthand students.

Rita Bassani earned a certificate for taking three letters at 80 words per minute and transcribing two mailable letters in 20 minutes, in shorthand II and transcription.

Carole Fiato's certificate represented shorthand speed for 100 words per minute for five minutes transcribed with 95 percent accuracy, also at the end of shorthand II and transcription.

Ann Sturtevant and Mary Ellen Tuck completed their second year of shorthand by taking three minutes of dictation at 80 words per minute and transcribing with 95 percent accuracy.

At the end of shorthand I four girls earned awards by taking five minutes of dictation at 60 words per minute and transcribing with 95 percent accuracy. They were Kristine Kline, Jacquelyn Ryan, Ann Marie Sullivan and Jill Turner.

The awards distributed are earned as a part of the Gregg Publishing Company awards program.

### Meeting Held

The September meeting of the Sales and Marketing Executives of Eastern New York, Inc. was held on September 11 at the Crossroads Restaurant.

Robert A. Pierson, Coordinator of Distributive Education at Bethlehem heard Arthur H. Motley, Chairman of PARADE Magazine, present a "Fifteen Word Sales Course." Mr. Motley is considered one of America's "Twelve Master Salesmen," and he is a member of the Distribution Hall of Fame.

### On Dean's List

Melinda Kriete, daughter of Mr. and Mrs. Gerald Kriete, Sr., Long Lane, Selkirk, a junior at SUNY, Cortland, has been named to the Dean's list. A 1971 graduate of RCS School, Melinda is majoring

in Physical Education and has a 3.6 average out of a possible 4.0.

She just completed a two week Outdoor Recreation and Survival Course at Raquette Lake, N.Y.

### Named to Who's Who

Gerald Kriete, son of Mr. and Mrs. Gerald Kriete, Sr., Long Lane, Selkirk, has been included in the current edition of "Who's Who Among American High School Students." Gerald is a senior at R-C-S and is active in wrestling, football, band, school newspaper, student government and various orchestras in the

*Your*  
**BANKAMERICARD**  
*welcome here*

## CLOSE OUT SALE

**WHILE THEY LAST**

WE HONOR  
**master charge**  
THE INTERBANK CARD

### PANASONIC TOOT-A-LOOP RADIO

**\$9.88 — reg. 15.95**

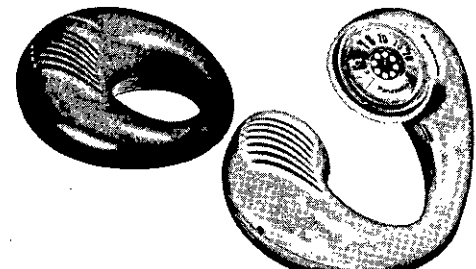

red  
white  
blue  
yellow

**R-72 The Toot-A-Loop**  
Our Craziest Crazy Color AM Portable Yet!  
Wear it. Swing it. Twist it. You can even listen to it!  
It's Panasonic fantastic new Toot-A-Loop.  
In 4 colors. Battery operation. Built-in antenna.  
2½" speaker. Solid-state engineered. With battery, earphone, and gift box.

## HILCHIE'S HARDWARE & GIFT SHOPPE

235 Delaware Ave., Delmar



## DON'T MISS THE BUS!

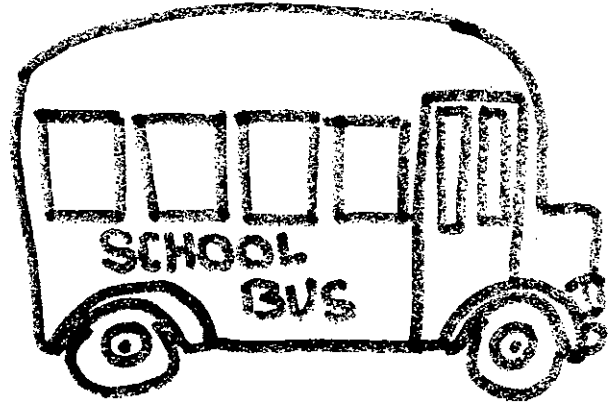

Go back to school with  
**GROVER'S STATIONERY**  
**WE HAVE THE**  
**LARGEST**  
**SELECTION OF**  
**SCHOOL SUPPLIES**  
**IN THE AREA**

**C. M. GROVER**  
**Stationers**

Delaware Plaza  
ELSMERE, N.Y.

**LOW    LOW    LOW**  
**INSURANCE RATES**

**AUTO — HOMEOWNER — FIRE  
CALL**

**THE INSURANCE OFFICE**  
**439-7646**

**HANDY HUT CERAMICS**

**ROUTE 9W and BEACON ROAD  
GLENMONT, N.Y.**

**Register now for fall classes.  
Saturday classes for teenagers.**

**449-8795**

*The  
Coach  
Houses At  
Woodgate*

*Woodgate is  
just minutes  
from major  
traffic arteries,  
5 minutes from  
Thruway Exit 23*



*The Delmar Condominium Community  
That Gives You Leisurely Living  
and the equity and tax deduction of home ownership*

The **charm** of early American coach houses nestled in the trees. The **peace** of meandering forest pathways — and picnic areas in the woods. The **fun** of over an acre of recreation area. Private patios. Swimming pools. And the **convenience** of having **all** outside maintenance looked after by professionals — leaving your leisure time for leisure. The **ease** of total electric living. And enclosed garaging.

The **financial** advantages of being a condominium community — the only way to enjoy the beauty, tax deductions and equity build-up of owning a home in Delmar without homeowner's headaches: no lawn to mow, leaves to rake or snow to shovel. Come see Woodgate for **yourself**. We can show you coach houses to suit any kind of lifestyle and each with a range of construction options to personalize them to the way you live.

**On Oak Road, just east of Cherry.  
2 blocks south of Kenwood.**

**WOODGATE**  
Condominiums at Delmar

**NON BINDING RESERVATIONS  
AVAILABLE.**

This advertisement is not an offering which can be made only by a formal prospectus. N.Y. No. 314 and No. 427

area. Upon graduation next June, he will enter SUNY at Potsdam as a music major.

## The American Farmer

(Editor's note: This is the fifth and final article in a series on the American farmer. The articles, furnished by DEKALB AgResearch, Inc., were written to help increase the public's understanding of the American farmer and the importance of agriculture to our economy.)

Efficiency is the name of the game. The gap between costs and prices represents profit. It's this gap that every farmer tries to keep as wide as possible.

The farmer has little control over the prices he receives. He can protect himself by hedging in the futures market, but this market, in itself, reflects a totally free supply-demand situation. Another alternative is to contract for sale of his crops, but when he does this he often trades off opportunity for top profits in favor of security.

Since the market doesn't respond to the farmer's wish, the most practical means of is to keep his production costs as low as possible. This is hard to do when the costs of his inputs keep rising. For example, between 1957-59 and 1969, farmers were faced with a 77 percent increase in hired wage rates, a 33 percent increase in the price of motor vehicles and a 106 percent increase in taxes.

Faced with a situation like this, farmers have been forced to seek efficiency — or else stop playing the game!

Even with recent increases in prices of agricultural commodities, the average income of the American farmer is still below that of his urban neighbors. In 1972, disposable income per farmer was still only 78 percent of that enjoyed by nonfarmers. It's ironic that this is the way the American farmer is rewarded for

his increase in productivity--an increase that far exceeds the increases in productivity of both his blue-collar and white-collar neighbors.

The cost-price squeeze is making it difficult for young farmers to get started. A recent study in Illinois found that nearly 20 percent of the farm boys who entered farming during the period 1945-54 failed to make it in that vocation.

Food prices have been drawing headlines recently. But, compared to income and increased prices of other products, food is still a bargain.

Given recent increases in food prices, it is a fact that these prices are lower now, in proportion to expendable income, than ever before in history. For example, consumer income increased 63 percent in the 1960's while the food expenditures were up only 31 percent during the same period. Income less food expenditures was up \$960 or 73 percent. Still, someone has to absorb the blame when prices do climb.

The farmer is seldom the cause of such increases, and he seldom benefits from an increase. He receives an average of 40 cents out of each dollar spent on food at the grocery store--the remainder goes for processing and marketing. Compare this 40 cents to the 50 cents he received from each food dollar in 1947-49.

Because of the many steps involved in food production, perhaps no one segment can be saddled with the blame when food prices rise. But keep in mind that the farmer does not willfully cause food prices to increase. He does not set the price on his goods at the marketplace. What he sells for a profit today may bring him a loss next week because of the simple economic law of supply and demand. How many other segments of our economy are willing to settle for that kind of security?

### HIS FUTURE

What about the future of the American farmer?

AT ADAMS

DOWNTOWN ALBANY

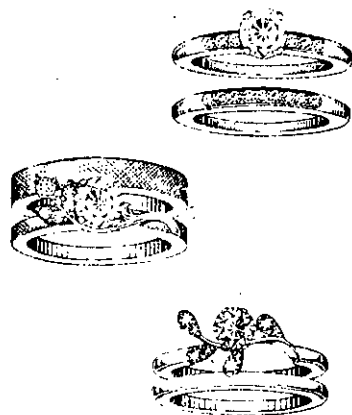

**IT'S SUMMER!**  
Which means Weddings,  
presents and love and lovers  
and  
**DIAMOND ENGAGEMENT  
ENSEMBLES**

*"Our name inside a diamond ring means better value —  
WE GUARANTEE IT"*

Shop Thursday  
til 9 P.M.

Frank H.

# Adams

• 30 days charges • 90 days no int. • Master Charge • BankAmericard

No. Pearl & Steuben Sts., Downtown Albany  
**FREE SAFE Parking at ALL 15 Park & Shop Lots**

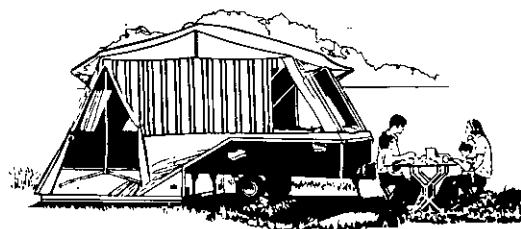

## Coleman Minuteman

It tows easily behind even the small economy cars, and the top flips back in less than 60 seconds to provide you with a big 40 square feet of living space. And an optional Camp 'N Cook Kitchen Set contains everything you need for whipping up any kind of a meal!

Come on down and look over the new flip-top camper today. It's the most revolutionary combination of ideas you'll ever see, and it's only \$695! Set yourself free in the new Coleman Minuteman!

## MAGLEY TRAILER SALES

CHUCK PLANT 1609 Western Avenue, Albany, N.Y. • 456-3611 BILL MURRAY JR.

# FOWLER'S LIQUOR STORE

257 DELAWARE AVENUE ELSMERE-AT-THE-LIGHT 439-2613

The Largest Selection of Half Gal.  
in the Capitol District.

We will not and can not  
be undersold.

Compare our prices with any advertised price.

## HORSE SHOE LOUNGE

RT. 9W, SELKIRK • 767-9905

Entertainment every  
Friday & Saturday night

Come to our grand opening

**Thursday, Sept. 20**

for a night of entertainment & fun

POPULAR PRICES • Open 7 Days a Week — 3 P.M.-3 A.M.

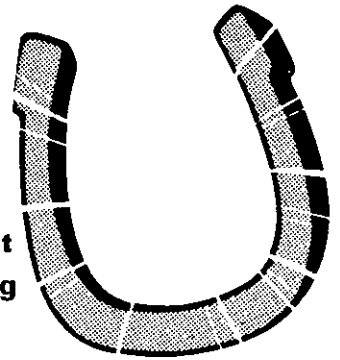

## FALVO'S HOME FOOD SERVICE

STONEWELL SHOPPING CENTER

1968 New Scotland Rd., Slingerlands, N.Y. • Phone HE 9-5398

**CHARGE IT WITH  
BANK-AMERICARD**



**FREE HOME DELIVERY**  
\$100.00 minimum

**SAVE AT FALVO'S  
AT STONEWELL**

U.S. CHOICE FULL <b>HINDQUARTER of BEEF</b> 160 lb. average lb.	<b>\$1.19</b>	ARMOUR — SELF BASTING GRADE A — 16/20 lb. avg. <b>TURKEYS</b> lb.	<b>79¢</b>
ALL MEAT CUT AND WRAPPED U.S. CHOICE FULL — 325 lb. avg. <b>SIDES of BEEF</b> lb.	<b>\$1.09</b>	FIRST PRIZE RIB CENTER CUT <b>PORK CHOPS</b> lb.	<b>\$1.49</b>
U.S. CHOICE WHOLE — 650 lb. avg. <b>CARCASS of BEEF</b> lb.	<b>\$1.03</b>	STORE SLICED <b>BOILED HAM</b> lb.	<b>\$1.59</b>
U.S. CHOICE OF WHOLE <b>RIBS of BEEF</b> CUT AND WRAPPED — 30 lb. avg. lb.	<b>\$1.29</b>	OUR OWN <b>MEAT BALLS</b> lb. JUST THE WAY YOU LIKE IT	<b>\$1.30</b>
U.S. PRIME — FULL <b>HINDQUARTERS of BEEF</b> <b>SIDES of BEEF</b> lb.	<b>\$1.29</b> <b>\$1.09</b>	ITALIAN LINK <b>SAUSAGE</b> hot or sweet lb.	<b>\$1.39</b>
WHOLE OR HALF <b>VEAL</b> (cut & wrapped, frozen) lb.	<b>\$1.19</b>	<b>GROUND CHUCK</b> 3 lbs. or more per lb.	<b>\$1.09</b>
WHOLE OR HALF GENUINE SPRING <b>LAMB</b> lb. (cut & wrapped, frozen)	<b>\$1.19</b>	<b>HAMBURG</b> 3 lbs. for pk.	<b>\$2.85</b>

He's likely to continue to decrease in number unless the rules of the game change. The relentless pressures of economies of scale, increasing technological complexities, high "start up" costs, and his minority political position combine to suggest that farms of the future will be fewer and bigger. But he's not going to be driven off by big, vertically integrated conglomerates. He's too tough a competitor, too flexible, too dedicated, for them.

He's important to America. He has made it possible for Americans to eat the best food at the lowest price in the world, and he is by far our biggest producer of foreign exchange. He's tired of being criticized because government production controls are necessary to avoid disastrous overproduction. Instead of being appreciated because he produces food at the lowest cost in the world, he hears demands for price controls when the price of his product starts moving upward for the first time in 20 years.

The United States faces a national policy choice: To continue to encourage him, to help him survive as the world's most efficient food producer; or, by shortsightedness, to force him into the control of marketing conglomerates through the ruthless economic pressures of disastrous overproduction.

Many in agriculture, including DEKALB AgResearch,

strongly support national policy that (a) helps him avoid overproduction and unfair prices, (b) helps him get credit on reasonable terms, (c) makes new technology available to him and (d) encourages the development of readily available, competitive markets for his products.

Let us all salute the American farmer ... the world's most important businessman. His amazing ability to produce has been a strong and positive force in the world economy.

## HERE AND THERE

### GOP Luncheon Set

A "Meet the Candidates Luncheon" at 12 noon Tuesday, September 25, has been set by the Women's Republican Club, Town of Bethlehem.

The menu and pleasant surroundings of Normanside Country Club will frame a most interesting program.

Richard Rosenbaum, Colonial Acres resident and chairman of the New York State Republican Committee, will be Speaker and Guest of Honor. He will be introduced by Town Supervisor Bertram Kohinke and followed by an introduction to us of Albany

### BUYING A WATCH?

**BETTER VALUE - BETTER SERVICE  
WE GUARANTEE IT**

See our Fine Collection

- Patek Philippe
- Girard Perregaux
- Movado
- Omega
- Adams
- Tissot
- Bulova
- Accutron
- Concord
- Caravelle

Frank H. *Adams*

JEWELERS • GEMOLOGISTS • HOROLOGISTS  
58 No. Pearl St., cor. Steuben  
ALBANY, N.Y.



Announcing . . .

# Special Fall

**FREE MAKE-UP CLASS  
OCTOBER 1 - 10:00 A.M.**

**HELENA RUBENSTEIN MAKEUP SPECIALIST**  
will be on hand to give demonstrations on  
makeup and application.

Also Private Consultation.

— Appointment Necessary —

*The Aquarius Beauty Salon, Inc.*

2 SALISBURY ST., DELMAR, N.Y.

## PICK YOUR OWN

### MacIntosh Apples

Sept. 22 & 23, from 9-5

We are now pressing  
**CIDER**

### Bartlett Pears

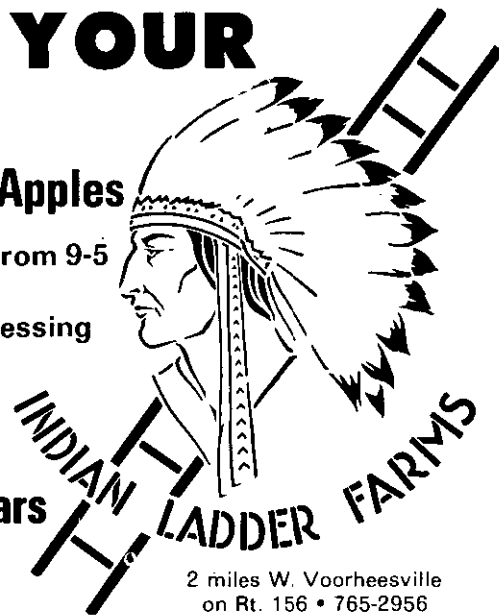

2 miles W. Voorheesville  
on Rt. 156 • 765-2956  
9-6 Weekdays • 10-6 Sundays

**WE ARE NOW BAKING:  
Old Fashioned Apple Pies  
Hot Cider Doughnuts  
Fresh Bread**

# Money Savers.

## Michelin Radials last twice as long as bias-ply tires.

An average driver will run up about 10,000 miles a year. At that rate, you can count on at least 4 years, or 40,000 miles from a Michelin steel belted radial tire. About double what you can expect from a bias-ply tire.

Why? Because they run cooler and reduce the risk of heat blowouts. They're flexible. And they absorb jolts like a cushion. You'll even save gas because they roll easier. Look into Michelin radial tires today.

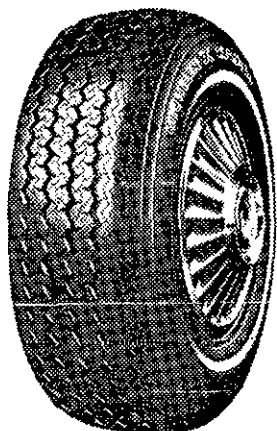

Our radial specialists will help you select the right tire for your car!

**MICHELIN**



## KISKIS TIRE CO.

**ALBANY**  
1394 CENTRAL AVE.  
1 BLOCK EAST OF NORTHWAY  
459-1143

**TROY-LATHAM**  
1/4 Mile North of Latham Circle  
On Route 9  
ST 5-5516

MONDAY TO FRIDAY 8 to 5:30 — WED. & FRI. EVE'S, 'TIL 8  
SATURDAY 8 A.M.-3 P.M.

**no children to spare...  
drive with care!**



Richard Rosenbaum

County Candidates appearing on this November ballot.

Everyone (of all political persuasions) is cordially invited to lunch with and meet the candidates.

For information and reservations call ticket chairman, Barbara Silber, 439-3639.

### At Texas Convention

Elizabeth Ann Kraus, 31 McKinley Drive, Delmar, attended the 25th International Achievement Conference sponsored by Field Enterprises Educational Corporation, publishers of The World Book Encyclopedia.

Miss Kraus, District Manager, was among the more than 2,400 World Book managers who met at the Music Hall in Houston, Texas, September 5 - 7.

### Demo Plan Garage Sale

The Committee to elect Mike Bergan Supervisor of the Town of Bethlehem announces a fund-raising Garage Sale October 6 at 1574 New Scotland Road, Slingerlands. If you have suitable items, such as toys, books, hand-crafts, household items, baked goods, anything except old clothes, drop them off at one of these locations: Janet Butlin, 25 Borthwick Ave., Delmar; Betty Bergan, 71 Elsmere Ave., Elsmere; Nancy Carter, 28 N. Helderberg Pkwy, Slingerlands; Mary Ellen Nichols, 33 Thatcher St., Selkirk; Ethel Mokhiber, Bethlehem Terrace, Slingerlands.

### Troop 58 Meets

Boy Scout Troop 58, sponsored by the Blanchard American Legion Post, held its first meeting at the Elsmere School on September 17 when awards for the summer trip were presented.

Eighteen scouts and five adult leaders of the Troop completed a nine-day wilderness canoe trip in the Algon-

**THIS WEEK'S SPECIALS**

**REGULAR**

**ROSES**

**\$5.00 doz.**

**DELAWARE GARDENS**

278 DELAWARE AVE., DELMAR, N.Y. • 439-4941





quin Provincial Park in Ontario, Canada. Scouts of Troop 58 who ventured over water with such interesting names as Canoe Lake; Baby, Little and Joe Lakes; Burnt Island Lake; Little and Otterslide Lakes; Otterslide Creek; Big Trout Lake and Longer Lake, included: William and Mathew Burkhard, Albert Brachthaeuser, Daniel Cassidy, James Carroll, Daniel and Michael Cronin, James DeGrush, Patrick Fasulo, Ernie Hannington, Norman Weuwissen, Douglas Monington, David Morrell, Jeffrey Morris, Donald Shaw, Mark Spelich, Jeffrey Stone, and Keith Smith.

Scoutmaster Kenneth Bauer was assisted by William Burkhard, Robert Carroll, Louis Spelich, and Robert B. Morris.

#### Committee Meetings

The Bethlehem Democratic Committee invites all committeemen and all people interested in canvassing for the election of candidates to these five meetings: September 18, at the Library; September 24, at The Bank; Oct. 8 and 22, at The Bank; and November 5, at the library. All meetings will be at 9 P.M. Anyone interested in working on the campaigns for supervisor, councilmen, Town Justice, Town Clerk, Highway Superintendent or County Legislators is welcome to attend any of these meetings.

#### Back Home

Navy Fireman Ralph Lento, son of Mr. and Mrs. Salvatore Lento of 11 Main St., and husband of the former Miss Mary Ellen Hagan of 25 Western Ave., all of Ravena, returned from an extended deployment in the Mediterranean area to his ship's homeport here.

#### Association Meeting

One Hundred Years of Grange History" will be the topic of the opening meeting of the Town of Bethlehem Historical Association at the Old Cedar Hill School House, Route 144, Selkirk, on September 20.

Mrs. Winston T. Raynor,

**20% OFF  
SALE  
on  
Specially  
Selected  
WALLPAPERS**

**ROGER SMITH**

PAINT & WALLPAPER CO.  
253 Delaware Ave.,  
Delmar, N.Y. 12054

**439-4468**

**Classes Now Forming**

**ELEANOR'S  
SCHOOL OF DANCE**

337 Delaware Avenue, Delmar

**Tap • Ballet • Modern Jazz • Baton**

**THREE YEAR OLDS THRU ADULTS**

**Saturday or weekly classes available**

**869-6611**

**489-0028**

**16th Year Serving the Tri-Cities**

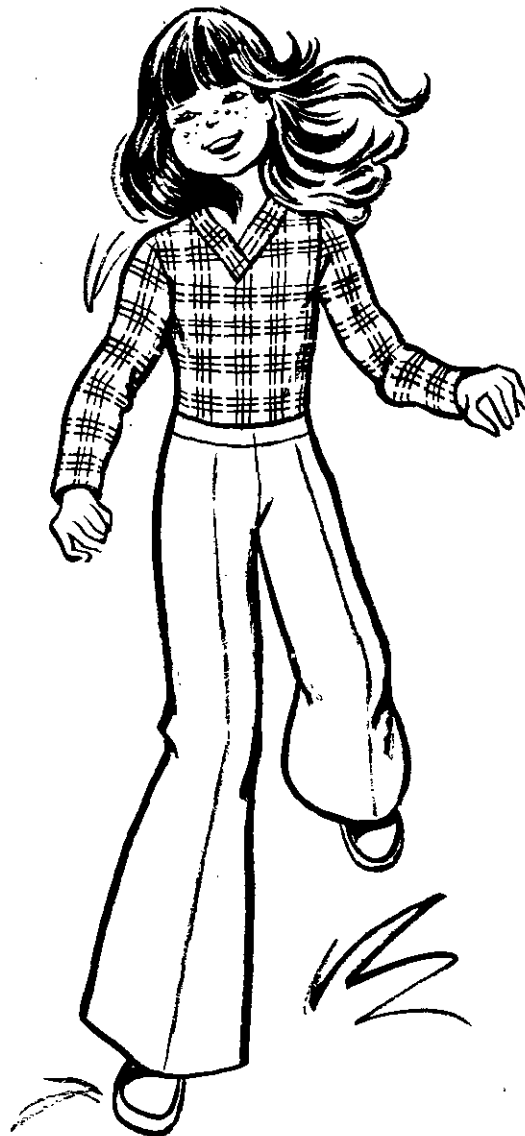

**SHE LOVES TO PLAY.  
YOU'LL LOVE OUR  
WEAR-DATED®  
DANSKINS**

plaid bodysuit 7.50, 8.50

solid slacks 10.00, 11.00

Also:

flip skirt 6.50, 7.50

turtleneck top 5.50, 6.50

plaid slacks 10.00, 11.00

Active comfort in Monsanto nylon, guaranteed for one full year's normal wear. In navy, red and pine colors. Sizes 4-6X, 7-14.

Young World,  
Delaware Plaza  
Troy and Stuyvesant Plaza

**DENBY'S**

# free checking

Purchase a Savings Certificate at The Bank for \$500 or more and you get a Free Personal Checking Account for the term of your certificate.

**6%** two-year savings certificate yields . . . . . **6.27%**

**5½%** one-year savings certificate yields . . . . . **5.73%**

Come into any one of our more than 55 conveniently located offices and learn the details.

**The Bank**  
National Commercial Bank and Trust Company

Member  FIRST COMMERCIAL BANKS INC.

Member F.D.I.C.



**SPOTLIGHT CLASSIFIEDS**  
**HE 9-4949**

wife of the late author of the book on Grange history, will be the speaker. Mrs. Raynor, who designed the cover of her husband's book, is presently Junior Deputy of Albany County Grange and Secretary of the Bethlehem Grange. She will be accompanied at the meeting on the 20th by long time members of the Grange who will assist in answering any questions the audience may have.

#### Church School Class

The First United Methodist Church of Delmar announces the beginning of a Mid-Week Church School Class for children grades one through five. First meeting of the group was Tuesday afternoon, September 18.

This class is taught by Mrs. Jane Lawrence and Mrs. Judy Diefendorf with Eilene Smith assisting. The class is modeled along the lines of the open classroom, and will serve as a Learning Center for the students. The theme for the fall semester, which runs through November 20, will be "Jesus Is . . ." Registration may be made on September 25.

A small registration fee is assessed for the Semester. Scholarship aid is available. This mid-week class is open not only to members and friends of the Church but to all youth of the community who wish to be part of this Learning Center.

#### Position Open

Postmaster Maurie G. Flanigan announces that an examination will be held for a Substitute Rural Carrier of Record for the Slingerlands, N.Y. Post Office, 12159. Opening date for filing applications will be Sept. 21, and closing date will be October 2, 1973.

Form 2479AB, application cards may be obtained at the Slingerlands Post Office.

#### Auction-Bazaar Planned

Autumn is on its way and along with it, the 22nd Annual Autumn Auction-Bazaar of the Voorheesville Methodist Church. On Saturday, September 29, visitors will again have a chance to browse

## PURINA PET PRODUCTS

Horse Chow  
Dog Chow  
Cat Chow  
Puppy Chow  
Omolene  
Rabbit Chow

## W.W. CRANNELL LUMBER

VOORHEESVILLE  
765-2377



### Special Band Instrument TRIAL PLAN for beginners

School bands are being formed now—so have your child ask the school band director which instrument is best for him. Then bring him in to choose from our complete stock of famous

### BUNDY

#### Band Instruments

designed especially for students. Also get details of our trial plan.



ALL BAND INSTRUMENTS  
AVAILABLE ON A  
TRIAL RENTAL —  
OPTIONAL PURCHASE PLAN

CONN • OLDS • BUNDY  
GEMEINHARDT

## JOHN KEAL'S MODERN MUSIC CO.

22 Central Ave., Albany  
449-5214

through many booths, be entertained, and find a choice of things to eat.

Bazaar booths will open at 10 A.M. and offer homemade candies and baked goods. Garden produce and home-canned foods from Granny's cellar will remind you of the

"good ole days." Start your Christmas shopping early at our Gift Booth where unique, one-of-a-kind items can be found. Find what you've been looking for in the bargains at the White Elephant, Book, Toy, and Used Clothing booths.



THE GOP OF GUILDERLAND PLANS DINNER — Mrs. Joan Hull, Ft. Hunter, Co-chairman of Dinner and President of Town of Guilderland Women's Republican Club, passes out tickets for the Dinner to two of the Town's Republican candidates; Don Munn, McKownville, Candidate for County Legislature, 33rd District, and John J. Welsh, McCormack's Corners, Incumbent Town Justice. The Dinner which is sponsored by the Town of Guilderland.GOP Organization will be held on Saturday, September 29, at 7 P.M. at the Ramada-Silo Restaurant in McKownville. Tickets can be obtained from any town GOP Committeeman or by contacting Ticket Chairman, MacDonald Kugler, Altamont, 355-8739 or co-chairman, Joseph Jones, Westmere, Phone 456-4794. The public is invited to attend.

COME SEE OUR FAKE FUR COLLECTION.  
JUST ARRIVED. TIGER, LEOPARD, PONY  
AND OTHERS. LUSCIOUS SOLIDS LIKE PINE  
GREEN, PURPLE AND SHEEPSKIN THAT  
LOOKS LIKE THE REAL THING. ALL WASH-  
ABLE, 60" wide — \$3.50 to \$5.50 yd.

Combine them with our ARTIFICIAL BUCK-  
SKIN (washable) and you have the look of  
today's fashion. In 8 smart colors.  
\$4.98 and \$5.50 yd.

*"The Home of Quality Fabrics"*

## DELMAR DECORATORS

DELAWARE PLAZA, DELMAR • 439-4130  
Daily 10-9 • Saturday till 5:30

# The Light Touch

Some courageous young men became test pilots and astronauts; others give driving lessons.

•••

If all the people who sleep in church were placed end to end, at least they'd be more comfortable.

•••

Teenager we know took a job aptitude test. He was found to be suited for retirement.

•••

At Delmar Lumber we're suited to fill your requirements for Scotts Lawn Products.



## A greener lawn in 10 days or your money back

- Satisfaction guaranteed! Full money back guarantee printed on every package
- Summer safe! Will not burn grass when used as directed
- No need to sprinkle off! Saves you time and effort
- Long lasting! Prolonged feeding helps keep grass green thru summer

## DELMAR LUMBER

340 Delaware Avenue  
Delmar  
Phone 439-9968

**SAVE up to \$40 on NEW EUREKAS 1973 CLOSEOUTS**

CANISTERS • UPRIGHTS • LIGHTWEIGHT

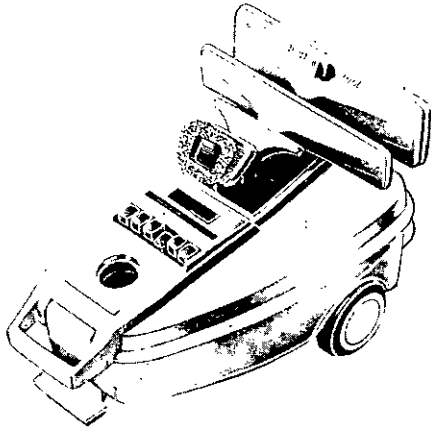

Model 1880-B



**LEXINGTON VACUUM CLEANER REBUILDERS**

62 Lexington Ave., Albany 465-4636

**NATIONAL INSULATION CO.**

64 HUDSON AVENUE  
DELMAR, NEW YORK

439-9924

**SAVE MONEY**

PROVEN FACT! 90% OF ALL HOMES, BE IT NEW OR OLD, ARE INADEQUATELY INSULATED. YOUR HOUSE CAN BE COOLER IN THE SUMMER AND WARMER IN THE WINTER.

LET US SHOW YOU HOW

**SAVE ENERGY and FUEL**

Call or Write For a Free Home Comfort Survey

Name .....

Street Address .....

Town ..... Zip .....

Phone .....

— SAVE MONEY AND FUEL —

At 11 A.M., auctioneer Jim Dunn will begin the bidding on the treasures accumulated for this year's auction.

Children of all ages will enjoy the entertainment planned from 10 A.M. to 3 P.M. Besides the game booths and plenty of popcorn, there will be children's movies and a clown to talk with. Special attraction this year will be the Moon Walk, a favorite at local fairs.

Everyone will enjoy the choice of refreshments offered at the Snack Shack and the Coffee Shoppe. To end a busy day, a youth dance is planned at 8 P.M. by the Methodist Youth Fellowship.

**Successful Season**  
The Tri-Village Legion base-

ball team sponsored by Nathaniel Adams Blanchard Post #1040, American Legion, came in second in the 1973 Albany County League. The team won the Albany County championship by defeating both Voorheesville and Fort Orange 2 games out of 3.

Pitchers for the local team were Jeff Young (5-0), Pete Toohey (5-1) and Shawn Fitzgerald (4-3). Top hitter was left fielder Gary Maher (.450). Other players were: Dan Barclay, Dick Brewster, Steve Caruso, Bill Donlon, Jim Flynn, Pete Flynn, Ken Gall, Mark Kerrigan, Glan Palmer, Kent Sellner, John Terko, Bill Toffenetti, and Mike Usher.

Manager Ernie Gall and



**DEMOCRATS GET TOGETHER TO EAT STEAK** — On September 9, Bethlehem Democrats got together for their annual Steak Roast at Murray-Jennex Park. Among the candidates present were, left to right, front row: Tom Magliocca, County Legislature; Mike Bergan, Supervisor; Felix Paquette, County Legislature; back row: Hank Dullea, Town Council; Dom DeCecco, County Legislature; Joe Brennan, Town Justice; Jack Leonard, Highway Superintendent; and Bill Burkhard, Town Council.

Thinking about a cruise for this fall, winter or spring . . . Myers Travel now has the new Cruise Guide. Don't forget our Albany departure on Dec. 7 to the Caribbean which may be obtained at either location.

37 North Pearl St.  
Albany, N.Y. • 434-4131



210 Delaware Ave.  
Delmar, N.Y. • 439-7671

coaches Gene Usher and Joe Caruso take this opportunity to thank Tom Toohey, Russ Denegar and Rudy Toffenetti for their assistance as well as parents and Legion members for their support — and Blanchard Post for its financial assistance.

### Open House

Has the crisp fall air and the fruit stands laden with juicy red-cheeked apples and golden pumpkins put you in the mood for fall picture taking. Autumn's fashion show of color is just around the corner:

Be photographically prepared this year by attending Delmar Camera Club's annual Community Open House to be held on Tuesday, Sept. 25, at St. Stephen's Episcopal Church.

Come any time after 8 P.M., browse, talk to club members, view the displays of black and

white prints, enjoy the colored slide presentations and ask questions. Whether your hobby is photography or you're just interested in viewing others' efforts, you'll find your time well spent. And there will be refreshments, too! All are welcome. Club members are urged to arrive early with pictures for exhibit.

### All About Scouting

Training in Scout program skills was experienced by more than 2,000 Scouts during the summer at the Camps operated by the Governor Clinton Council, Boy Scouts of America, according to James Beck, Scout Executive.

As part of their year round camping program, 100 Scout troops attended the camps including one of the newly formed Scout troops for handicapped boys.

The Governor Clinton Council provides a Scout pro-



EVERYONE NOTICES THE FLOWER BOXES in front of the stores at the Delmar Four Corners. Toward the end of each summer, a committee of BEIA members judges the one deemed most beautiful. This year's award certificate goes to Spinosa's Barber Shop. The picture shows what careful watering and a little TLC will do.

# FREE!

## \$69<sup>95</sup>\* Toro® Starter

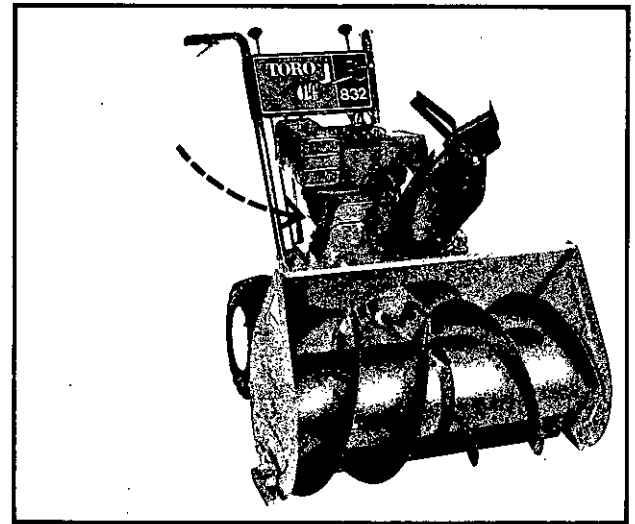

From now until November 30 you can get a free electric starter on any Toro two-stage snowthrower. A nice feature to have on those sub-zero mornings when you discover a foot of fresh snow on your driveway. In addition to electric starting, there's the Toro "safety grip system" which shuts the machine off auto-

matically when the safety handle is released. And there's two-stage action which lets the larger models hurl up to a ton of snow a minute! Cash in on our \$69.95\* savings and discover the difference Toro engineering can make.

Haven't you done without a Toro long enough? **TORO**

Offer expires November 30, 1973.

# TAYLOR & VADNEY

303 CENTRAL AVE., ALBANY  
Open Mon., Tues. & Sat. 8 to 5 • Wed., Thurs. & Fri. 8 to 8  
Tel. 472-9183

HOURS: 10:00AM. - 6:00PM. MONDAY THROUGH SATURDAY



## SHUTTLE HILL HERB SHOP

256B DELAWARE AVENUE DELMAR, NEW YORK 12054  
corner of Delaware & Elsmere Ave., behind Pharmacy

SHUTTLE HILL CULINARY HERBS & HERB BLENDS	SPICES -and- SEASONINGS	LARGE SELECTION of FINE TEAS HERB TEAS
JAMS and JELLIES	 ANTIQUE COLLECTABLES SHAKER-INDIAN- NANTUCKET BASKETS	CARDS and NOTEPAPERS
SHUTTLE HILL HERB-WINE VINEGARS HERB MUSTARDS	HERB PLANTS UNUSUAL HOUSE PLANTS SEEDS	DRIED ARRANGEMENTS DISTINCTIVE GIFTS

gram for Albany, Rensselaer and Columbia Counties and has a current Scout membership of about 11,000. It operates two, year-round camps; Camp Stratton a 2,000 acre wilderness area in the Green Mountains of Vermont and Camp Rotary, a 1500 acre facility in Rensselaer County.

In addition to the regular summer camping program, over 200 area Scouts attended the week long National Scout Jamboree at Moraine State

Park in Pennsylvania and another 100 Scouts traveled to the National Scout Camp in Philmont, New Mexico.

"All of these types of camping experiences are highlights for the program of the troops. Scouts learn and apply the skills they have been dreaming about all year, and it's a year's worth of adventure compressed into a week or so," the Scout Executive explained.

As a part of the Council Camping Program, some 20

needy Scouts were provided financial assistance under the Council campership program, so that they could attend a Scout camp.

Beck also said that a special School Night to Join Scouting will be held on October 3 at public schools throughout the Capital District area to enable boys and their parents to find out more about the Scout program in their neighborhood and join their local Cub Pack or Scout Troop.

"Last year over 1,000 new Scouts joined on School Night and 12 brand new units had to be established. We anticipate an even larger turn-out this year as more and more boys discover the many programs and adventures that Scouting has to offer," Beck said.

**HUNTER TRAINING**

With the small game and waterfowl seasons opening on October first throughout most of upstate New York, hunters will be rushing in to renew

their hunting licenses during the next several weeks.

To keep the ranks of hunters filled this year, some 90,000 aspiring hunters must successfully complete the required hunter safety course before they can qualify for their license.

If you are one of these new hunters don't put off taking the training until the last moment. Instructors of these courses are all volunteers who are also ardent hunters so it is

# GRAND UNION

## 1,550 EXTRA BONUS STAMPS

**NOW!** DISCOUNT TICKETS FOR "SARATOGA RACEWAY" AT YOUR FRIENDLY GRAND UNION

**YOU SAVE 50¢** TOWARD EITHER GENERAL OR CLUBHOUSE ADMISSION

GENERAL REG. PRICE 1.75 — MEMBERSHIP PRICE 1.25 YOU SAVE 50¢  
 CLUBHOUSE REG. PRICE 3.00 — MEMBERSHIP PRICE 2.50 YOU SAVE 50¢

ONE TICKET PER PERSON. PURCHASE WITH 10 STAMPS. STAMPS WITH 150¢ ETC.

**KLEENEX**

**TERI TOWELS**

ROLLS OF 60

**3 FOR 1.00**



**DEEP FLAVOR**

**SALADA TEA BAGS**

PKG. OF 100

**99¢**



**GRAND UNION**

**BOOK MATCHES**

PKG. OF 50

**10¢**



**GRAND UNION**

**FROZEN PEAS**

10 OZ. PKG.

**19¢**



**CORN FED WESTERN PORK SALE**

### PORK LOINS

<b>CENTER CUT PORK CHOPS</b>	<b>RIB PORTION</b>	<b>LOIN PORTION</b>
<b>1.49</b>	<b>89¢</b>	<b>99¢</b>
lb.	lb.	lb.
PLUS STAMPS	<b>RIB SIDE L.B. 99¢</b>	<b>LOIN SIDE L.B. 1.09</b>
	<b>PORK CHOP COMBINATION</b>	<b>END &amp; CENTER CHOPS L.B. 1.29</b>



**CHICKEN PARTS**

GOVT. GRADE "A" FRESH BREASTS OR THIGHS **99¢**

**FAMILY PAKS** 3 LBS. OR MORE

<b>GRAND UNION BOLOGNA</b>	<b>1.09</b>	<b>MORE MEAT VALUES</b>
<b>GRAND UNION LIVERWURST</b>	<b>1.09</b>	<b>COLONIAL BRAND SMOKED BUTTS</b> WATER ADDED <b>1.49</b>
<b>GRAND UNION PORK CHOPS</b>	<b>99¢</b>	<b>COLONIAL POLISH SAUSAGE STICKS</b> <b>1.49</b>
		<b>GRAND UNION BALONEY</b> <b>1.19</b>

**FROZEN MEAT & FISH VALUES**

<b>GRAND UNION PERCH FILLET</b> EL DORADO	<b>1 LB. PKG. 93¢</b>	<b>GORTON'S IN LEMON BUTTER SAUCE</b> <b>9 OZ. PKG. 99¢</b>
		<b>GORTON'S FILLET OF SOLE</b> <b>2 LB. 1.59</b>

**DELICATESSEN**

TRUNZ, DUTCH LOAF, PICKLE & PIMENTO

**BAKED LOAVES** OR **PEPPER L.B. 69¢**

**SALAMI STYLE PROVOLONE CHEESE** **1/2 L.B. 59¢**

**FRESH, CREAMY COLE SLAW** **L.B. 39¢**

**CUDAHY MARGHERITA PEPPERONI** **L.B. 59¢**

**HOME STYLE MACARONI & CHEESE** **L.B. 65¢**

**IN SAUCE STUFFED PEPPERS** **1/2 L.B. 65¢**

**DELI ITEMS IN THIS BLOCK AVAILABLE AT STORES WITH SERVICE DELI COUNTERS ONLY**

**SAVE! 99¢**

WITH THESE COUPONS

**TRASH CAN LINERS**  
PKG. OF 20



**88¢**

**BAYER ASPIRIN**  
BOT. OF 50



**43¢**

**CALIFORNIA LARGE SIZE Cantaloupes 3 FOR 1.00**

HUDSON VALLEY PRUNE PLUMS  
ITALIAN STYLE LB. **25¢** PLUS STAMPS

CALIFORNIA BARTLETT PEARS N.Y. STATE-U.S. NO. 1 YELLOW LB. **29¢**  
COOKING ONIONS 3 LB. BAG **39¢**  
DELICIOUS EGGPLANT FLORIDA-LARGE SIZE LB. **19¢**  
AVOCADOS EA. **39¢**

**50¢ OFF** WITH THIS COUPON  
TOWARD THE PURCHASE OF ONE 8 OZ. JAR

**MAXIM INSTANT COFFEE**  
GOOD THRU SAT., SEPT. 22  
(LIMIT 1-PER CUSTOMER)  
TOWARD THE PURCHASE OF ONE 8 OZ. JAR

**34¢ OFF** WITH THIS COUPON  
TOWARD THE PURCHASE OF TWO 22 OZ. BOTS.

**LIQUID JOY DETERGENT**  
GOOD THRU SAT., SEPT. 22  
(LIMIT 1-PER CUSTOMER)  
TOWARD THE PURCHASE OF ONE 33 OZ. BOT.

**15¢ OFF** WITH THIS COUPON  
TOWARD THE PURCHASE OF ONE 33 OZ. BOT.

**DOWNY FABRIC SOFTENER**  
GOOD THRU SAT., SEPT. 22  
(LIMIT 1-PER CUSTOMER)

**SAVE ON THESE FROZEN FOOD VALUES**

SARA LEE RASPBERRY COFFEE RING 10 OZ. PKG. **75¢**  
SARA LEE ALMOND COFFEE RING 10 OZ. PKG. **75¢**  
CHUN KING CHICKEN OR SHRIMP CHOW MEIN 15 OZ. PKG. **69¢**

GRAND UNION-SLICED STRAWBERRIES 16 OZ. PKG. **53¢**  
GRAND UNION CUT OR FRENCH GREEN BEANS STYLE 2 9 OZ. PKGS. **49¢**  
GRAND UNION PEAS & ONIONS 2 10 OZ. PKGS. **49¢**

THIS SAVES YOU UP TO 17¢ COMPARED TO NATIONALLY ADVERTISED BRANDS. WE GUARANTEE YOUR COMPLETE SATISFACTION OR DOUBLE YOUR MONEY BACK.

SANDWICH OR BUTTERMILK FRESHBAKE BREAD  
1 LB. 6 OZ. LOAF **35¢** PLUS STAMPS

100 EXTRA STAMPS  
WITH THIS COUPON & PURCHASE OF ONE 3 LB. BOX-DETERGENT

**COLD POWER**  
GOOD THRU SAT., SEPT. 22  
(LIMIT 1-PER CUSTOMER)

100 EXTRA STAMPS  
WITH THIS COUPON & PURCHASE OF ONE ANY JAR-MARIE'S

**SALAD DRESSING**  
GOOD THRU SAT., SEPT. 22  
(LIMIT 1-PER CUSTOMER)

100 EXTRA STAMPS  
WITH THIS COUPON & PURCHASE OF ONE 1/2 GAL. LOT. FRESH FLORIDA PASTEURIZED ORANGE JUICE OR GRAPEFRUIT

**ORANGE JUICE**  
GOOD THRU SAT., SEPT. 22  
(LIMIT 1-PER CUSTOMER)

**1,550 EXTRA BONUS STAMPS** WHEN YOU CLIP & REDEEM THESE COUPONS

50 EXTRA STAMPS  
WITH THIS COUPON & PURCHASE OF TWO 24 OZ. CANS

**KAL KAN BEEF CHUNKS OR STEW**  
GOOD THRU SAT., SEPT. 22  
(LIMIT 1-PER CUSTOMER)

50 EXTRA STAMPS  
WITH THIS COUPON & PURCHASE OF ONE 2 LB. BAG-SCHOHARIE VALLEY

**FRESH CARROTS**  
GOOD THRU SAT., SEPT. 22  
(LIMIT 1-PER CUSTOMER)

50 EXTRA STAMPS  
WITH THIS COUPON & PURCHASE OF ONE 2 LB. BAG-BETTY ZANE

**POPPING CORN**  
GOOD THRU SAT., SEPT. 22  
(LIMIT 1-PER CUSTOMER)

50 EXTRA STAMPS  
WITH THIS COUPON & PURCHASE OF TWO 24 OZ. BOXES

**NINE LIVES DRY CAT FOOD**  
(BEEF, TUNA OR LIVER & CHICKEN)  
GOOD THRU SAT., SEPT. 22  
(LIMIT 1-PER CUSTOMER)

50 EXTRA STAMPS  
WITH THIS COUPON & PURCHASE OF FOUR 17 OZ. CANS-GREEN GIANT

**WHOLE CORN KERNEL**  
GOOD THRU SAT., SEPT. 22  
(LIMIT 1-PER CUSTOMER)

50 EXTRA STAMPS  
WITH THIS COUPON & PURCHASE OF TWO 22 1/2 PKGS.-BETTY CROCKER

**BROWNIE MIX**  
GOOD THRU SAT., SEPT. 22  
(LIMIT 1-PER CUSTOMER)

50 EXTRA STAMPS  
WITH THIS COUPON & PURCHASE OF TWO 18 OZ. PKGS.-PILLSBURY MIX

**FRUIT'N CRUNCH**  
GOOD THRU SAT., SEPT. 22  
(LIMIT 1-PER CUSTOMER)

50 EXTRA STAMPS  
WITH THIS COUPON & PURCHASE OF TWO 7 OZ. PKGS.-STOVE TOP CHICKEN OR CORNBREAD

**STUFFING MIX**  
GOOD THRU SAT., SEPT. 22  
(LIMIT 1-PER CUSTOMER)

50 EXTRA STAMPS  
WITH THIS COUPON & PURCHASE OF TWO 12 OZ. PKGS.

**APPIAN PIZZA WAY**  
GOOD THRU SAT., SEPT. 22  
(LIMIT 1-PER CUSTOMER)

50 EXTRA STAMPS  
WITH THIS COUPON & PURCHASE OF TWO PKGS. OF INSTANT

**MAYPO OR MALTEX**  
14 OZ. PKG. 18 OZ. PKG.  
GOOD THRU SAT., SEPT. 22  
(LIMIT 1-PER CUSTOMER)

50 EXTRA STAMPS  
WITH THIS COUPON & PURCHASE OF ONE 32 OZ. BOT.-VLASIC

**KOSHER CHIPS**  
GOOD THRU SAT., SEPT. 22  
(LIMIT 1-PER CUSTOMER)

50 EXTRA STAMPS  
WITH THIS COUPON & PURCHASE OF TWO 4 OZ. PKGS.-LIPTON SOUP MIX (WITH BROTH)

**CHICKEN NOODLE**  
GOOD THRU SAT., SEPT. 22  
(LIMIT 1-PER CUSTOMER)

50 EXTRA STAMPS  
WITH THIS COUPON & PURCHASE OF TWO 46 OZ. CANS

**ORANGE APRICOT B.C. DRINK**  
GOOD THRU SAT., SEPT. 22  
(LIMIT 1-PER CUSTOMER)

50 EXTRA STAMPS  
WITH THIS COUPON & PURCHASE OF ONE 8 OZ. PKG.-KRAFT

**CRACKER BARREL SHARP CHEDDAR SPREAD**  
GOOD THRU SAT., SEPT. 22  
(LIMIT 1-PER CUSTOMER)

50 EXTRA STAMPS  
WITH THIS COUPON & PURCHASE OF ONE 14 OZ. CAN

**PLEDGE REG. OR LEMON**  
GOOD THRU SAT., SEPT. 22  
(LIMIT 1-PER CUSTOMER)

50 EXTRA STAMPS  
WITH THIS COUPON & PURCHASE OF ONE PKG. OF 6-CARNATION (ALL VAR.)

**INST. BREAKFAST**  
GOOD THRU SAT., SEPT. 22  
(LIMIT 1-PER CUSTOMER)

50 EXTRA STAMPS  
WITH THIS COUPON & PURCHASE OF ONE 7 OZ. SIZE

**RENUZIT SOLID AIR FRESHENERS**  
GOOD THRU SAT., SEPT. 22  
(LIMIT 1-PER CUSTOMER)

50 EXTRA STAMPS  
WITH THIS COUPON & PURCHASE OF ONE 40 OZ. PKG.

**SNOWY BLEACH**  
GOOD THRU SAT., SEPT. 22  
(LIMIT 1-PER CUSTOMER)

50 EXTRA STAMPS  
WITH THIS COUPON & PURCHASE OF FOUR 17 OZ. CANS-GREEN GIANT

**SWEET PEAS**  
GOOD THRU SAT., SEPT. 22  
(LIMIT 1-PER CUSTOMER)

50 EXTRA STAMPS  
WITH THIS COUPON & PURCHASE OF FOUR 16 OZ. CANS-GREEN GIANT SLICED OR FR. STYLE

**GREEN BEANS**  
GOOD THRU SAT., SEPT. 22  
(LIMIT 1-PER CUSTOMER)

50 EXTRA STAMPS  
WITH THIS COUPON & PURCHASE OF SIX 6 OZ. CANS-CONTADINA

**TOMATO PASTE**  
GOOD THRU SAT., SEPT. 22  
(LIMIT 1-PER CUSTOMER)

50 EXTRA STAMPS  
WITH THIS COUPON & PURCHASE OF ONE 9 OZ. OR 14 OZ. CAN

**SURE ANTI-PERSPIRANT**  
GOOD THRU SAT., SEPT. 22  
(LIMIT 1-PER CUSTOMER)

50 EXTRA STAMPS  
WITH THIS COUPON & PURCHASE OF ONE PKG. OF 26

**POLIDENT TABLETS**  
GOOD THRU SAT., SEPT. 22  
(LIMIT 1-PER CUSTOMER)

50 EXTRA STAMPS  
WITH THIS COUPON & PURCHASE OF ONE PKG. OF 24

**KOTEX SANITARY NAPKINS**  
GOOD THRU SAT., SEPT. 22  
(LIMIT 1-PER CUSTOMER)

50 EXTRA STAMPS  
WITH THIS COUPON & PURCHASE OF ONE ANY SIZE PKG.

**BAND-AID ADHESIVE BANDAGES**  
GOOD THRU SAT., SEPT. 22  
(LIMIT 1-PER CUSTOMER)

**DOUBLE STAMPS EVERY WEDNESDAY!**

NOT RESPONSIBLE FOR TYPOGRAPHICAL ERRORS      WE RESERVE THE RIGHT TO LIMIT QUANTITIES      PRICES AND OFFERS EFFECTIVE THRU SAT., SEPT. 22

quite understandable that they plan to schedule their instruction prior to the hunting season.

These 4,200 instructors work closely with the Department of Environmental conservation to help insure that a uniform program is being given but they are strictly on their own when it comes to scheduling classes. In most cases, it is an activity of a local sportsmen's club, so if you do not see announcements

of hunter training classes in the local newspaper contact your nearest sportsmen's club. The local environmental conservation officer has no official activity in these courses but through contact with the organizations, most know of classes. He certainly can give you the names and addresses of key sportsmen in the community who could answer your inquiry.

When the hunter training program started in 1949, it

applied only to those who were age 17 or younger. The marked reduction in hunting accidents that occurred following the inauguration of the course prompted many other states to develop similar ones. New York has now expanded its program.

When the program first started, it was strictly a hunter safety program. Many instructors were distressed at the steady increase in the

amount of posting of private land caused by hunters who did not have the traditional hunting ethic of respect for the landowner, the land, other hunters and the game itself. They began incorporating some of this into our program and it spread until it is now a vital part of the course. Safety is in no way downgraded but it is stressed that the hunter without a good hunting ethic is the hunter who is causing the posting

which could mean an end to the hunting in much of the more populated areas of the northeast.

Many people are not aware that the Penal Law sets forth the basic regulation governing the use of firearms by those under 16 years. With two exceptions, it clearly states that it is unlawful for anyone to sell or give any firearm, air or spring gun or ammunition thereof to any person under 16 years of age.

## STARTS MONDAY, SEPT. 17 AT GRAND UNION...

# Cannon's newest

no-iron  
decorator  
collection  
in high fashion  
stripes  
florals and

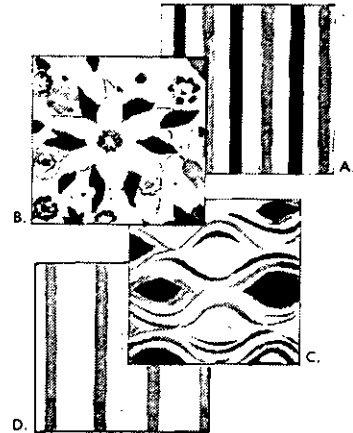
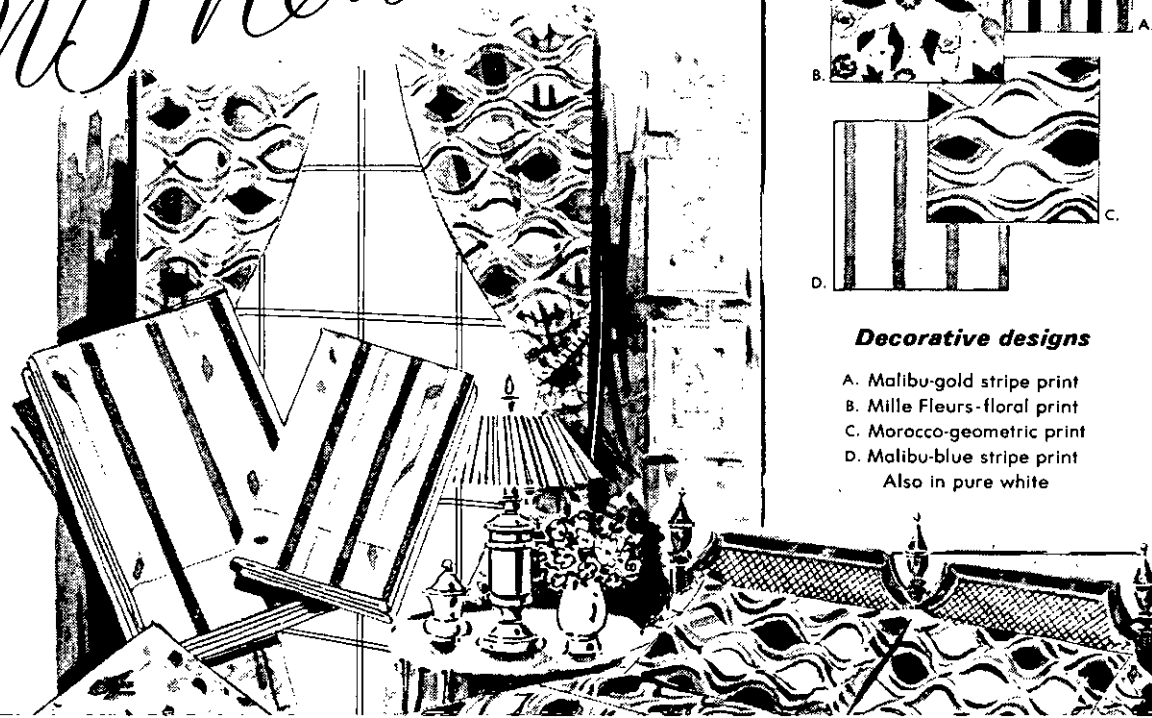

### Decorative designs

- A. Malibu-gold stripe print
  - B. Mille Fleurs-floral print
  - C. Morocco-geometric print
  - D. Malibu-blue stripe print
- Also in pure white



at Grand Union

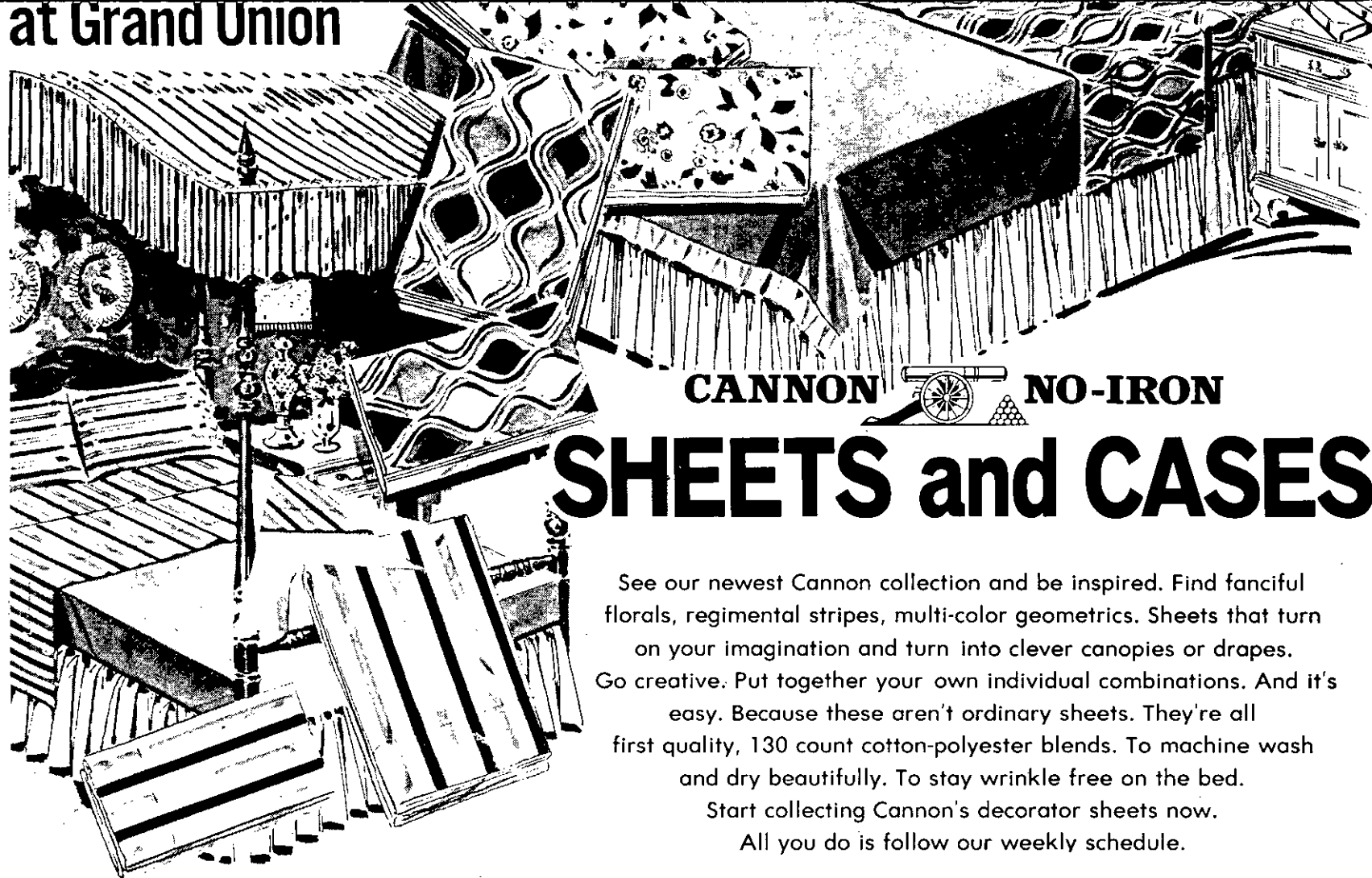

CANNON  NO-IRON

# SHEETS and CASES

See our newest Cannon collection and be inspired. Find fanciful florals, regimental stripes, multi-color geometrics. Sheets that turn on your imagination and turn into clever canopies or drapes. Go creative. Put together your own individual combinations. And it's easy. Because these aren't ordinary sheets. They're all first quality, 130 count cotton-polyester blends. To machine wash and dry beautifully. To stay wrinkle free on the bed.

Start collecting Cannon's decorator sheets now.

All you do is follow our weekly schedule.

Follow this weekly schedule to get your Cannon collection

Every Week	1st Week	2nd Week	3rd Week	4th Week
<b>PILLOW CASES*</b> <b>\$169</b> <b>\$199</b> <small>PKG. OF 2</small> <small>PKG. OF 2</small> white prints	<b>TWIN FLAT SHEETS*</b> <b>\$199</b> <b>\$249</b> white prints	<b>TWIN FITTED SHEETS*</b> <b>\$199</b> <b>\$249</b> white prints	<b>FULL FLAT SHEETS*</b> <b>\$299</b> <b>\$349</b> white prints	<b>FULL FITTED SHEETS*</b> <b>\$299</b> <b>\$349</b> white prints



NOT RESPONSIBLE FOR TYPOGRAPHICAL ERRORS

WE RESERVE THE RIGHT TO LIMIT QUANTITIES

LUXURY FOR HIRE

434-8921

# CADILLACS

Hourly Rates or Miles  
(No Minimum)

AMERICAN EXPRESS  
ACCREDITED

*Executive  
Limousine*

Be creative.  
be correct...

COLOR STYLE  
YOUR HOME

with  
PRATT & LAMBERT  
PAINTS

*in exclusive Calibrated Colors®*

Ed Dillon

EMPIRE PAINT COMPANY

142 Central Avenue  
Albany, New York 12206  
Phone 449-5400

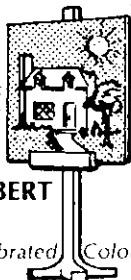

N.Y.S. OFFICIAL  
Inspection Center

# L & H

Brake & Front End Service  
115 Adams Street, Delmar  
HE 9-3083

Alignment  
Wheel Balance  
Mufflers & Tail Pipes  
Brakes  
Front End  
Springs.

The Penal Law permits 12 to 16 year olds to receive instruction from duly qualified adults on a regular rifle range using rifles no larger than .22 calibre rim fire. It is this authority that makes possible the firearms programs given at many summer camps, schools and sportsmen's clubs.

The other exception is Section 11-0929 of the Environmental Conservation Law. This permits 14 and 15 year olds who have successfully completed their four-hour training program to obtain a hunting license. The license must be signed by the minor's parent or guardian before the issuing agent. It is valid in the field only when he is accompanied by his parent or guardian who holds a license to hunt or is accompanied by a license holder of at least 21 years of age who is designated in writing by the parent as being responsible for the minor's supervision.

Safe hunting habits are not acquired in a four-hour class. Safe practices may be learned but it takes many days in the field with careful practice before they become safe habits. The adult accompanying the young hunter should always be close enough so that he can give the proper supervision. It is not only an ideal learning situation for the minor but is an opportunity without equal for father and son to work together and get to know each other better.

### Learn to Sew with Knits

Whether you have a basic knowledge of sewing or are already an accomplished seamstress, you now have an opportunity to learn the special techniques that make knit sewing simple and thereby reduce the time ordinarily required to construct knit sewing. During this 10-week course, you will learn to make trim-fitting pants, a T-shirt, dress, suit jacket, pull-over and cardigan sweaters, vest. Classes will be primarily demonstrations with work sessions interspersed.

## A FEAST THE GODS COULD ENVY

Let the Altamont Manor entice you into a gourmet adventure. Come sit at a table spread with many wonderful dishes. Enjoy a magnificent view of the Hudson-Mohawk Valley as you sample to your heart's content from over 15 intriguing specialties to be found on our unequalled Gourmet Table... fresh mushrooms a la Greque, taramosalata, tabuli, baba ganouj, dolmathes, hot spanakopita and many more.

Greek dinners complement traditional American entrees and prices for full dinners including the Gourmet Table start at just \$5.95. And on Sunday, only, a meal for Zeus himself, just \$9.50.

**Altamont Manor** Call for reservations  
861-6277

Open till Mid-November



### THERE'S A NEW WAVE ABOUT TOWN

Soft, silky curls and healthy, glowing hair. It's part of the natural look. Feel totally feminine. Let us introduce you to a beautiful new hairstyle. Call.

**FALL SPECIAL**  
**\$20 Perm \$13.50**

(NORMAL HAIR ONLY)



## PAULINE'S Style Centre

PAULINE GIBSON

412 Kenwood Avenue Phone: HE 9-1217

Classes will be taught through the Bethlehem Central Adult Education program at the Middle School.

**Silver Anniversary**

On September 8, Mr. and Mrs. Robert O. White, 148 Kenwood Avenue, Delmar, celebrated their 25th Wedding Anniversary with a party given by their five children. Guests came from Maine, New Hampshire, and from throughout the Capitol District.

**You Can Beat Jack Frost**

Gardeners faced with a killing frost and vines loaded with unripened tomatoes may be able to salvage some of them for later eating, advises a Cornell University specialist.

After all the green tomato pickles and relishes have been made, additional green tomatoes can be picked and stored for later ripening, says Prof. Leonard D. Topoleski of the vegetable crops department at the N.Y. State College of

Agriculture and Life Sciences at Cornell.

Green tomatoes should be picked before the first killing frost and should be stored in a dark place at a temperature of about 55 degrees. Then, as needed, a few of the tomatoes can be moved to a 70 degree temperature for ripening.

"With luck, fresh tomatoes from the garden may be served with Thanksgiving dinner," Topoleski said. "Sometimes, they make it to Christmas," he added.

Winter squash and pumpkins don't present the problems that tomatoes do, Topoleski said, but they should be picked, also, before a heavy frost. The secret of long storage with these vegetables, he said, is to cut the stem from the vine as fruit without a stem will not store well.

They should be harvested after they have developed the appropriate color for the va-



**Thank You Bethlehem!**  
We're glad you learned

**"WHATEVER IT TAKES . . .  
ALBANY DODGE gives"  
MAKE US PROVE IT!**

**C. B. CLARKE, INC.**  
FOR  
**INSURANCE**  
CALL



**BURT ANTHONY**

**DID YOU KNOW WE SELL CAR INSURANCE?  
WE DO!**

**JUST CALL 439-9958**  
339 Delaware Avenue, Delmar



**COVER STORY**

FINGER-TIP CATCH!

LAST SATURDAY, area high schools opened their 1973 football season. Bethlehem Central played host to Scotia before a large crowd that cheered almost every local play. Bethlehem won the game 14-0. On the cover, Tony Danckert snags a touchdown pass with his fingertips to score in the last few seconds of the first half. In the picture on this page, Bethlehem's punter gets off a good fourth down kick. Jim Fuller photos

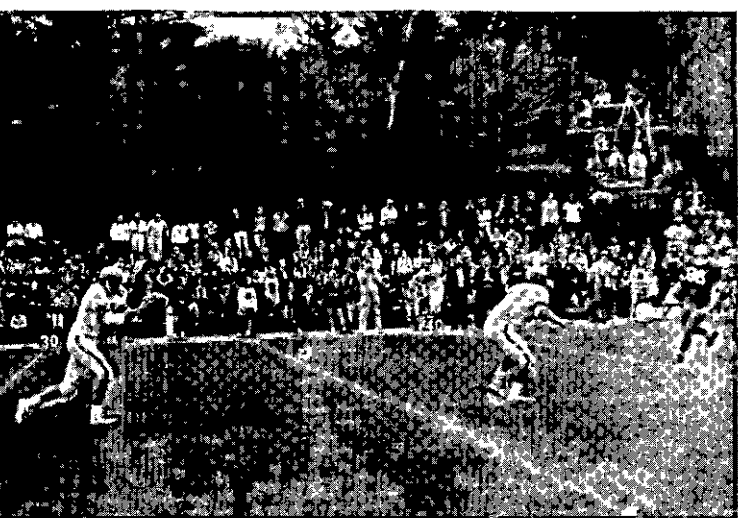

"GOOD FENCES MAKE GOOD NEIGHBORS"

**Cape Cod Fences**

MAINE CEDAR FENCES SHIPPED DIRECT FROM OUR MILL - GIVES YOU FINE QUALITY,



STOCKADE available in 3, 4, 5, 6, 6½, 8' HEIGHTS



POST & RAIL



CHAIN LINK Galv. or Vinyl Covered

RESIDENTIAL & COMMERCIAL

- Post & Rail • Screen
- Chain Link • Split Rail
- Picket • Basket Weave
- Pool Enclosures —

**PROFESSIONAL INSTALLATION**  
FINANCING AVAILABLE  
FREE ESTIMATES

— ALSO —

- GARDEN TOOL HOUSES
- DOG HOUSES • MAIL BOXES
- COPPER LANTERNS
- PICNIC TABLES

**785-0552**

**Cape Cod Fence Co.**  
888 Troy-Schenectady Rd., Latham, N.Y.  
1 Mi. West of Northway on Rt. 7



# Fast Photo Service

local color roll processing . . .

leave Monday, back Wednesday

leave Thursday, back Saturday

Complete Photo Needs Dept.

## L. J. MULLEN PHARMACY

"At Your Service - Everyday of the Year"

256 Delaware Avenue

Elsmere, New York

439-9356

Never a busy signal

riety and a hard rind. Storage should be in a dry place at room temperature.

Onions are mature when the tops fall over. After pulling them from the soil, they should be left in the sun for seven to 10 days for further drying and curing. After cutting off the tops, the onions will keep for several months if stored at temperatures above freezing but as cool as possible.

### Swimming Class

An American Red Cross swimming class for handicapped will be run for ten Saturday mornings at the Bethlehem Central Middle School swimming pool in Delmar, starting on Saturday morning, September 22, it was announced today by James H. Carnahan, Director of Safety Services Programs for the Albany Area Chapter.

This is one of the pioneer programs of the Albany Area Chapter of the Am. Red Cross and is being conducted by volunteers under the supervision of Mrs. John Joyce, Albany, for the past ten years.

Applications may be received and registration made

by writing to the Albany Area Chapter of the American Red Cross, Clara Barton Drive, Albany, N.Y. 12208.

An American Red Cross Junior and Senior Life Saving Course for boys and girls will be conducted at the Bethlehem Central Middle School, Delmar, on Thursday evenings from 7 to 10 P.M. starting on November 1. There will be no charge for this course, but each student will be expected to purchase a text book costing one dollar on the opening session.

Registration may be made by writing to the Water Safety Department, Albany Area Chapter, American Red Cross, Clara Barton Drive, Albany, N.Y. 12208.

Students in the Junior Life Saving Course must be at least 11 years old and be able to swim 200 yards. Students in the Senior Life Saving section must be at least 16 years of age and be able to swim 400 yards at the opening session.

### Adult Education at Center

The Albany Jewish Community Center announces that its ever popular Adult Educa-

tion program will start this fall on October 8. Registration for all courses are now in progress and will continue on through October 7. On weekdays, registration hours will be from 9:30 to 4:30 and 7:30 to 9:30 p.m. Courses are open to the general public as well as to Center members.

Among the more unusual courses to be given this year are Decoupage with Evelyn Eisner as instructor and Bicycle Repair for adults taught by Andy Scherer. A brand new course, Belly Dancing, an interpretive art form to develop and tighten abdominal muscles, will be offered by Diane Jordan.

Jerry Salata will again conduct his always oversubscribed Pottery and Ceramics class. Patsy Morris will teach Paint-

ing and Drawing emphasizing technique, composition and sketching. Marge Foster of the Bethlehem Art Association, will teach painting with an orientation to experimentation and also a course in oils and acrylics.

Ballroom Dancing classes will be given by Marge Tynan of the Tommy Sternfeld Studios. Separate classes will be held for beginners and intermediates. For those people interested more in Creative Modern Dance, Ida Gilman of the Capital District Modern Dance Council will conduct both beginner and intermediate sessions.

Hans Frenkel will present three Yoga classes in Hatha Yoga and one in Yoga Philosophy.

More than 35 courses in all



## Meyers Funeral Home

439-5560  
DELMAR, N. Y.

### Question:

I have been receiving a monthly benefit from my deceased husband's Social Security earnings. I am going to marry a man who is also receiving Social Security. Will each of us continue to receive benefits?

### Answer:

Yes, but the amount will not be the sum of the amounts you are now receiving individually. The income provisions applicable under the old law have been revised and improved.

Under the present law, if you are both over age 60 when you marry, the amount your husband is receiving will remain the same. You will receive whichever of the following benefits is larger:

1. One half of the retirement benefit of your deceased husband —  
or
2. A wife's benefit based upon the earnings of your prospective husband.

will be offered at the Center this fall, Samuel Kurzon, Executive

Anyone wishing further information may call the Center, 438-6651 or come in person, 340 Whitehall Road for a brochure listing all courses and fees.

#### State Conference

The New York State Conference of the National Society Daughters of the American Revolution will be held at the Waldorf-Astoria in New York City from September 26 through September 28. Mrs. George U. Baylies of Scarsdale, the State Regent, will preside at the business sessions. A highlight of the conference will be a tea and reception at the Morris-Jumel Mansion on the last day.

Albany delegates from the Tawasentha Chapter will be Mrs. Robert H. Taylor, Regent; Mrs. Everett S. Willoughby, Vice-Regent; and Mrs. Robert A. Jackson, Chaplain. Two other members of Tawasentha Chapter are members of State Committees with Mrs. Hildreth C. Bailey serving as

Chairman of the New York State DAR Student Loan and Scholarship Fund, and Mrs. Alice H. Anderson as a member of the American History and Awards Committee.

#### Car Pools and Insurance

School days may be the "good old Golden Rule days," but they are also car pool days.

Once again, as schools throughout New York get into full swing, mothers are banding together in driver groups to transport their kids back to the world of the three Rs.

At the same time, the current gasoline shortage and heightened concern over air pollution have sparked a resurgence of interest in share-the-ride plans among New York commuters.

Joining a car pool can be a convenience and a time and money saver — as well as a way of improving the quality of our air, but many people are reluctant to enter such arrangements.

They fear they will expose themselves to a lawsuit which won't be covered by their

## Annual Antique Show & Sale

Sponsored by  
THE LATHAM BUSINESS  
& PROFESSIONAL WOMEN'S CLUB  
(To Benefit Their Scholarship Fund)

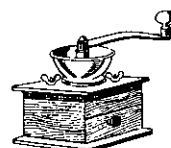

SHAKER JR. HIGH SCHOOL, ROUTE 155, 1/2 MILE EAST OF ROUTE 9.  
(USE EXIT 5, ROUTE 87 — NORTHWAY) LATHAM

Saturday, September 29 from 11:00 a.m. to 10:00 p.m.  
Sunday, September 30 from 12:00 noon to 6:00 p.m.  
Refreshments available

This is a Holiday House Antique Show

## Summer End Clearance TAR EMULSION. DRIVEWAY SEALER

5 gal. container **\$4.75** plus tax  
Reg. \$6.95

Stop driveway pollution, resist gas & oil, fills cracks, cleans easily, easy to apply.

**GORMAN BROS. INC.**  
PORT OF ALBANY

472-9342 462-5401



## BE AN EARLY BIRD PLAN YOUR CHRISTMAS PROJECTS — NOW

## The Cardinal Yarn Shop

NEEDLEPOINT — CREWEL — RUGS  
DANISH CROSS STITCH — YARN

412 KENWOOD AVENUE  
DELMAR  
439-0331

OPEN MON.-FRI. 10-5  
SATURDAY 10-1  
FREE INSTRUCTIONS



**CANDIDATES AND PLANNERS MEET AT SUNNY ACRES** — Local Republican candidates met with planners from the Bethlehem Men's and Women's Republican Clubs to make final plans for the Republican picnic to be held at Sunny Acres Day Camp on Elm Avenue Extension Sunday, September 23. The picnic will begin at 2 and end at 6 with free refreshments, a round robin softball tournament featuring teams from Bethlehem's Volunteer Fire Departments, and everyone will have an opportunity to meet and talk with the local Republican candidates. In the picture, from left to right, Bertram E. Kohinke, candidate for Supervisor; Mrs. Clayton Bardwell, Bethlehem Women's Republican Club; Marion Camp, candidate for Town Clerk; Bernie Kaplowitz, candidate for Albany County Legislature, 35th District; Martin Cross, candidate for Superintendent of Highways; and Tom Scherer, vice president of the Bethlehem Men's Republican Club and chairman of the picnic committee.

Jim Fuller photo

THE UNIQUE  
BOUTIQUE

Country  
Corner

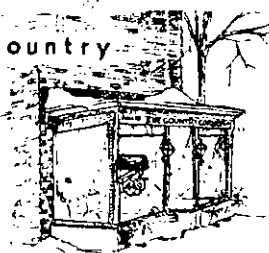

## FOR IMAGINATIVE GIFTS

come to

## The Country Corner

Open Mon. thru Sat. 10-6 • Thurs. evenings 'til 9  
Telephone 439-6671 • 449 DELAWARE AVENUE, DELMAR  
(Next door to Delmar Public Library)



**Douglas G. Marone**  
DISPENSING OPTICIAN

1 Delaware Plaza (Facing Delaware Ave.)

Open 10 to 5 Daily  
Saturday 10 to 2  
Evenings by Appointment

TEL. HE 9-9191

**SCHAGHTICOKE,**  
NEW YORK

## ANTIQUE FLEA MARKET

Schaghticoke Fair Grounds -- Junction N.Y. Routes 67 and 40

**SATURDAY, SEPTEMBER 22 - 10 a.m. to 6 p.m.**

Sponsored by Women's Association of Stillwater United Church

PARKING FOR 3,000 CARS  
DONATION 50c

REFRESHMENTS AVAILABLE  
This is a  
HOLIDAY HOUSE  
ANTIQUe SHOW

RAIN OR SHINE  
Howard J. Tooley, Mgr.  
Delanson, N. Y.

## THE KNIT & PURL SHOP

135-1/2 MAIN STREET, RAVENA, N.Y.

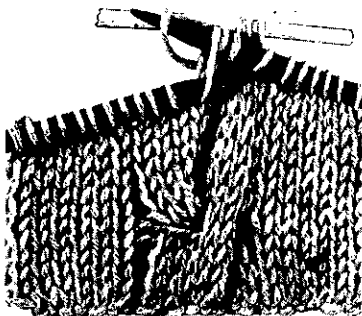

**ANNOUNCES A 10 WEEK  
COURSE IN KNITTING &  
CROCHETING.**

Beginners & Advanced  
Classes to begin Mon., Oct. 1st  
Registration Fee \$5.00  
Initial Supplies Furnished  
Call Mary Lauricella 756-2001  
or 756-6443 to register

*Mother Hubbard's  
Cupboard  
253a Delaware Ave.  
Delmar*



*wooden spoons  
utensils  
bowls  
lucite cutting boards  
pot holders  
cookie cutters  
ice cream sauces  
crystalized ginger  
and more*

regular auto insurance.

The Insurance Information Institute advises that, in terms of insurance coverage, car poolers probably have nothing to worry about. However, a few words of caution and explanation are in order.

Insurance on a privately owned, pool-shared vehicle is placed in jeopardy only if the pool is operated for a profit. In the situation where everyone in the pool uses his car an equal amount of time there is, of course, no problem.

The problem most often arises when one of the car pool participants does not share in the driving chores and thus pays a regular fee.

To preserve insurance coverage, the Institute points out, any car pool fee should not be more than the fair share of the gas, oil and general depreciation on the car. A simpler way for the non-sharing passengers to reimburse the pool members is to give a gift sometime during the year to the drivers.

This divorces the concept of "fee" from the privilege of riding in a car pool and leaves the insurance protection intact.

In the case of car pools in-

volving children, the Institute stresses the importance of wearing seat belts not only to protect the children in the case of an accident but also to prevent the kind of antics that

(continued)

## TOO LATE TO CLASSIFY

**GARAGE SALE**, furniture, books, frames, just about anything, Sat.-Sun., Sept. 22-23, 10 A.M.-8 P.M. 969 New Scotland Rd., Albany.

**TRACTOR LAWN MOWER**, Montgomery Ward, 8 HP, used 2 seasons. 439-9807. 21927

**1 MUSKRAT COAT**, size 14-16; 1 black seal coat, size 12-14; 1 marmink stole, size 12-14; picture frames. 439-1288. 21927

**BABY ITEMS**, excellent condition: crib, \$20; dressing table, \$15; infant carrier, \$2; expando fence, \$8. 439-6315.

**BICYCLE** - 20", 1-speed buys "Stingray", excellent condition. 439-1688.

**25 BALES OF insulation**, for walls & ceiling, very reasonable, please call daytime. HE 9-2236. 21927

**ELECTRIC SUNBEAM** "Champ" snowblower, practically new, three position, discharge 220, throwing radius, \$88.00. 439-1892.

**CALIFORNIA BOUND**, selling: furniture, clothing, etc. Plus garage sale, 76 Brockley Dr., Delmar. 439-1810.

**GREATEST BARN SALE** ever, antiques, collectables, furniture, pictures & frames, gas & oil light fixtures & parts, printers bench & print, old farm implements, milk cans, hospital bed comp., something for everyone. #419 Elm Ave., Delmar, just off Rt. 32, south, Sept. 29 & 30, 8 A.M. to dark (rain date Oct. 6 and 7). 21927

**ELECTRIC PIANO**, Maestro, walnut finish, \$300. Water bed, single liner, frame, used one month, \$50.00. Call 439-7926.

**AUTOMOTIVE FOR SALE**  
**1966 CHEV. 2 DR.** Biscayne, 6 cyl. \$175.00. 439-2679. 21104

**REAL ESTATE FOR RENT**  
**\$250 - COMPLETELY** furnished house, available Nov. 1st to May 1st. 439-9698.

**APT. FOR RENT** - Ravenna, heated, furnished or unfurnished, first floor living room, dining room, kitchen, bedroom & bath, mature couple or single lady only. Call 489-4166 after 4:00.

## BARGAIN DAYS

EVERY DAY IS BARGAIN DAY AT

# Tool's

## RESTAURANT

283 DELAWARE AVENUE, DELMAR • 439-9111

Where else can you get  
the Highest Quality Possible?

Prepared properly in our kitchen, priced  
to fit the family pocketbook.

Service & attention that will please you.

Make it a family occasion and eat at  
**TOOL'S**

Cocktails for Mom & Dad  
**FREE! Shirley Temples for the children!**

OPEN 7 A.M.-8 P.M. - CLOSED SUNDAY

# DELIVERANCE



**ALBANY COUNTY LEGISLATURE CANDIDATES** — Residents of the Town of Bethlehem, with the exception of the first and tenth districts in parts of Slingerlands and North Bethlehem, will have an opportunity to vote for these three Republican candidates: left to right, Earl Robinson, Ed Sargent and Bernie Kaplowitz. During the current year, Albany County legislative districts were redistricted according to the 1970 census figures. As a result, the Town of Bethlehem will have three full representatives instead of the previous two. Bernie Kaplowitz joins incumbent candidates Robinson and Sargent. The new districts now break down as follows: 34th Legislative District, Earl Robinson — 2, 9, 12, 15, 16 and 18th Election Districts; 35th, Bernie Kaplowitz — 8, 11, 13, 14 and 17th Election Districts; 36th, Ed Sargent — 3, 4, 5, 6, 7 and 19th Election Districts.

## CHRISTMAS IN SEPTEMBER?

It's not too soon to pose for Christmas portraits. Professional portraits take time and extra care for quality work.

Make your appointment now.

### Riccardo Studios

Maple Ave., Selkirk, N.Y.  
767-9891



## UNWANTED HAIR PROBLEM?



HAD ELECTROLYSIS OR SHORT-WAVE AND THE HAIR GREW BACK? WE'LL DO IT RIGHT OR WE'LL DO IT FREE!

### PAMELA STUART SYSTEM

213 Standard Bldg., 112 State St.  
Albany, N.Y. • 463-8369  
— 10-7 Daily —

## We'll make your motor sing



- \* Engine Tune-up
- \* Front End Alignment
- \* Automatic Transmission Service
- \* Modern Equipment
- \* Skilled Mechanics

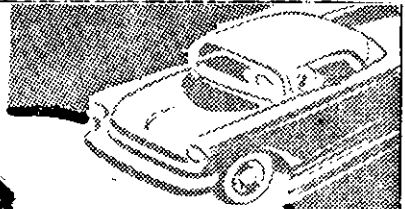

## BAILEY'S GARAGE

Phone Delmar HE 9-1446  
Oakwood Rd., Elsmere

## WAREHOUSE BARGAIN ROOM

## SUBURBAN GAL

99 DELAWARE AVE., DELMAR  
OPEN MON TO SAT.  
10 A.M. TO 5 P.M.

# SAVE UP TO 90% OFF

ON FAMOUS MAKER FALL AND WINTER FASHIONS

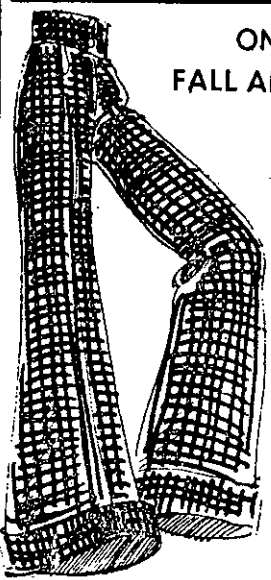

OVER 300 PAIR JR. & MISS **PANTS**  
REG. TO 24. **3.99 5.99 7.99**

FANTASTIC SAVINGS ON HUNDREDS OF OTHER FASHION BARGAINS

COATS • PANT SUITS  
SKIRTS • SWEATERS  
TOPS • LONG & SHORT  
DRESSES • HAND BAGS  
RAIN WEAR ETC.

LIMITED QUANTITIES ALL SALES FINAL



Get the COMPLETE story of this area in the **Spotlight** every week of the year. One way to be assured of receiving the next 52 issues is to fill in the blank below. Yes, we'd like to add your name to an ever-growing list of PAID subscribers!

Please enter my  renewal  new subscription to the **Spotlight**. I have enclosed \$3 for the next 52 issues.

NAME .....

STREET ADDRESS .....

P.O. .... ZIP .....



**SAVE UP TO 23% on  
AUTOMOBILE  
INSURANCE**

Over age 25 drivers  
as low as \$109

Under age 25 and single  
as low as \$254

Under 25 and married  
as low as \$206

**BARRY SCOTT**

Suite 720, 90 State St.  
Albany • 462-9796, 462-9891

Schatz   
**THE  
Wedding  
Center**

- Invitations
- Announcements
- Napkins
- Matches
- Wedding Cake Boxes
- Plus All Other Stationery And Accessory Needs

WE FEATURE  
CRANE'S INVITATIONS

24 Hour Service  
If Desired

**Schatz**

Mohawk | Colonie  
Mall | Center  
Open 9:30 to 9:30 Daily

**NO FINER  
TRIBUTE**

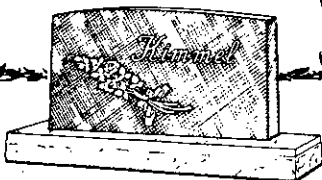

**MEMORY  
STUDIOS**

1032 Central Avenue  
Only authorized  
Rock of Ages Dealer  
in Albany County  
438-4486



**Ravena-Coeymans-Selkirk**

By Sandy Martone

756-9374

**Father Joe to Leave**

The Reverend Joseph Milillo will be honored with a farewell tea on Sunday, September 23, from 2-5 P.M. The tea is being sponsored by Saint Patrick's Rosary Altar Society, The Parent Student Association, The Catholic Daughters, and the Knights of Columbus, and will be held in Saint Patrick's School Hall. Father Milillo has served in the priesthood for over 42 years, and 12 of these years have been spent in Ravena. Father is now retiring and will sail for Italy, his native homeland on September 28. Area residents have fondly called him Father Joe and over the years he has gained many friends. Everyone will miss Father Joe and will certainly give him a very warm send off on Sunday.

**At Seminar**

Joseph DiPerna, a member of the RCS School Board, attended the seminar for new school board members presented by the New York State School Boards Association on September 7 and 8 in Albany.

The seminar program emphasized the role of the school board as a corporate body and the importance of setting policy for the district. Filmed case studies of school board

problems were seen and discussed as part of the two-day program. Other topics covered in the program included school finance, school board-employee relations, public information responsibilities, and the role of the chief school administrator.

The New York State School Boards Association, which represents the publicly selected leadership of nearly 3,500,000 school children in the state, has its headquarters in Albany. Its staff is headed by executive director Donald G. Brossman.

**Communion Dinner**

The Rosary Altar Society of Saint Patrick's Church will hold its annual Communion Dinner on October 1, following a six o'clock Mass. A roast beef dinner will be served at the Star Lite Lounge, Orchard Avenue, Ravena, at 7 P.M. The price of the dinner is \$5 per person and reservations must be made by September 23. For reservations, call one of the following: Mae Himes — 756-6986; Clara Doherty — 756-6220; Rae Nolan — 756-2670; St. Patrick's Rectory — 756-8534.

All Rosarians and their friends are cordially invited to attend.

**WINES & LIQUORS  
UNLIMITED**

A THOUSAND WINES in stock  
A THOUSAND DECANTERS  
on display  
all at discount prices  
Rt. 9W, Ravena • 756-2081



The American Red Cross

advertising contributed for the public good



**ANSWERING  
SERVICE**

Business & Professional

Telephone Exchange

24 hours a day

Call

**439-4981**

**TREESCAPE**

ARBORICULTURAL SERVIC.

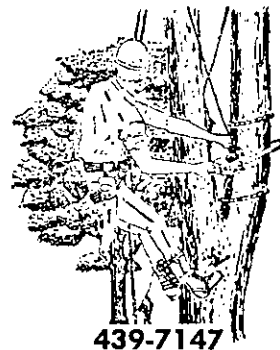

**8 complete kitchens  
on display**

**MILLBROOK KITCHENS**

FACTORY SHOWROOM  
Daily 8:30 - 5:00 • Sunday 1:00 - 5:00



20 min. drive from Delmar on  
Rt. 20, Nassau, N.Y. • 766-3033

WE HAVE

APPLES —  
Macs,  
R.I. Greenings

**SWEET CIDER**



BARTLETT PEARS  
STANLEY PLUMS  
DAMSON PLUMS

**SHEAR FARM  
COUNTRY STORE**

Rt. 143 756-2314  
4 miles west of Ravena  
Open 7 days a week.



might distract the driver's attention.

As an example, says the Institute, limits of \$300,000/\$500,000 would provide up to \$300,000 coverage for one injury in an accident with a \$500,000 per accident limit.

Medical payments is another important coverage. If written with limits of \$1,000, each person in the car can receive up to \$1,000 for medical ex-

penses incurred within one year of an accident regardless of who is at fault. The Institute emphasizes that because the dollar limit applies to each passenger separately, there is no need to increase the limits in order to cover additional passengers.

Subscribe to The Spotlight



**Consult Us with CONFIDENCE**

*"The Old Reliable"*

**EMPIRE MONUMENT CO.**

Cemetery Ave.-Menands

**SEE WHAT YOU BUY**

Large Stock of Finished MONUMENTS AND MARKERS

Work Erected Anywhere  
For Your Convenience Open Sat. & Sun.

Phone: 463-3323 463-3077

**Three programs in one to help you lose weight and keep it off!**

The **New** Weight Watchers' program.

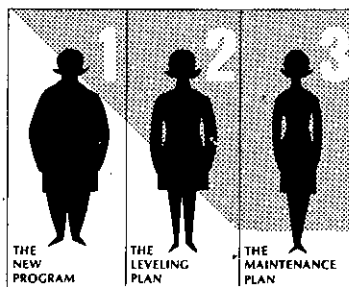

489-8323

**WEIGHT WATCHERS**

WEIGHT WATCHERS AND ARE REGISTERED TRADEMARKS OF WEIGHT WATCHERS INTERNATIONAL, INC. GREAT NECK, N.Y. WEIGHT WATCHERS INTERNATIONAL, 1972

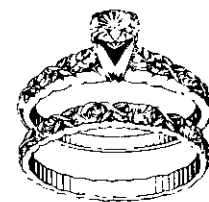

*Tradition*

From \$295.00

**Kelly's Jewelers**

88 Central Ave., Albany  
449-5187

Tues.-Sat. 9:30-5:30  
Thurs. til 9, closed Mon.



Here's Something Worth Shouting About!

Our extra care in your remodeling is what makes the difference.

**FOR A FREE ESTIMATE CALL ANYTIME 767-9387**



**HOME REMODELING HEADQUARTERS**  
ONE CALL DOES ALL  
ESTIMATES • FINANCING • CONSTRUCTION

- Kitchens
- Bathrooms
- Heating Systems
- Family Rooms
- Interior and Exterior Work
- Roofing & Siding
- Room Additions
- Floors & Carpets
- Doors & Windows

ROUTE 9W • SELKIRK, N.Y.

**NEED A NURSE THAT CARES?**

Our RN's, LPN's, Aides and Companions are second to none in training and experience. Just as important is the attitude of each MPP nurse. We are a national service, insured, bonded & ready to help. Day or night, call



Suite 1107 - 90 State St.,  
Albany • 463-2171  
Complete nursing service  
available 24 hours



**DEITCHER'S INC. WALLPAPER**

**FACTORY OUTLET**

all brands for less  
1st QUALITY  
**SAVE \$\$\$**  
40 thousand rolls in stock  
188 Remsen St.  
Cohoes, N.Y.  
Tel. 237-0101

**WHY TRAVEL FOR THE BEST FOOD WHEN YOU HAVE THE BEST FOOD IN DELMAR**



**WE FEATURE!**

- Italian Cuisine
- Prime Ribs **6.50**
- Steak Sandwiches **5.00**
- Shrimp Scampi **4.95**
- Seafood Dinners **from \$3.75**

Entertainment Nightly from 9 P.M. by **WALT STANLEY** — greatest organist in the country — playing three organs & grand piano

**Come Early for Dinner and Entertainment**

**The NEW ELSMERIAN RESTAURANT**

Delaware Plaza, Elsmere

**439-9898**

JOE LAZARE'S  
**WESTGATE**  
LINCOLN·MERCURY

# CLEARANCE

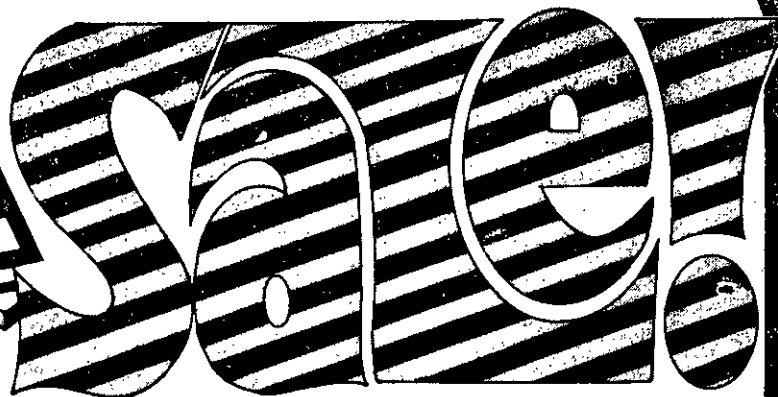

## ON HUGE SELECTION OF REMAINING BRAND NEW 1973 CAPRIS

- Capri V-6 (shown)  
(2600 cc) (155 cu. in.)  
Overhead valves  
8.2:1 compression ratio

- Capri 2000 (not shown)  
(2000 cc) (122 cu. in.)  
Overhead cam  
8.2:1 compression ratio

Weber 2-venturi carburetor  
used on both Capri 2000 and V-6

IMCO emission control

35-amp. alternator

Floor shift  
transmission  
4-speed manual (standard) or  
Select-Shift automatic (optional)

Bucket seats

Rear anti-sway bar

Front-hinged rear quarter windows

Fuel fill

12.7 U.S. gallon fuel tank

- Dual-pipe exhaust with  
Capri V-6

- Single exhaust with  
Capri 2000

Rear axle ratio  
3.44:1 with  
Capri 2000

Rear axle ratio  
3.22:1 with  
Capri V-6

Energy-absorbing  
Improved rear bumper

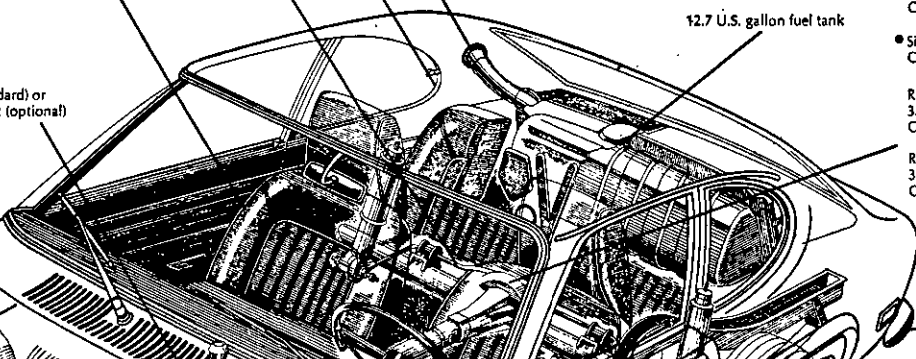

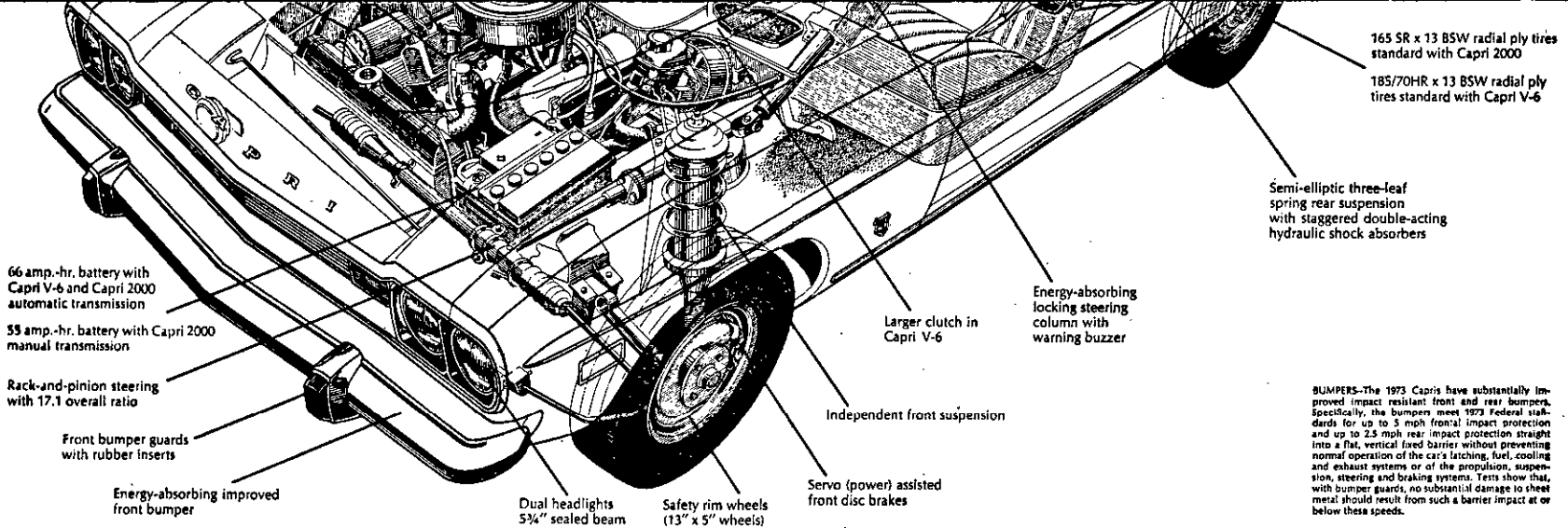

**BUMPERS**—The 1973 Capris have substantially improved impact resistant front and rear bumpers. Specifically, the bumpers meet 1973 Federal standards for up to 5 mph frontal impact protection and up to 2.5 mph rear impact protection straight into a flat, vertical fixed barrier without preventing normal operation of the car's latching, fuel, cooling and exhaust systems or of the propulsion, suspension, steering and braking systems. Tests show that, with bumper guards, no substantial damage to sheet metal should result from such a barrier impact at or below these speeds.

## The Sexy European

2000cc OHC Engine, 4 speed manual transmission, power front disc brakes, styled steel wheels, front and rear bumper guards, bucket seats, wood-toned instrument panel, cigar lighter, radial ply tires.

**ORIGINAL LIST \$3242**

FOR IMMEDIATE DELIVERY

# \$2999

**"THE COME BACK TO ME DEALER"**



JOE LAZARE'S  
**WESTGATE**  
 LINCOLN • MERCURY

Member of Albany Auto Dealer's Association

**945  
 CENTRAL  
 489-5421**

# CLASSIFIEDS

439-4949

439-4949

**ALUMINUM SIDING**

**COMPLETE LINE** aluminum products. Installation. Local references on request. Guaranteed workmanship, free estimates. Dick Domermuth — 768-2429. tf  
**ALUMINUM SIDING**, new plastic coated. All colors in stock, no down payment, 30 year guarantee. Free estimates. Statewide Modernization Corp., 104 Quail St., IV 9-0991. tf  
**ALUMINUM SIDING** installations, gutters, ice slides, trim, repairs. Also carpentry, masonry. 439-1593. 4t1011

**APPLIANCES**

**Bob Sowers' DELMAR APPLIANCE**

Complete line of RCA Victor • Whirlpool

SALES & SERVICE  
 239 Delaware Ave., Delmar  
 Phone 439-6723

**BICYCLES**

**Meyers Bicycle Center**



Service All Makes • 1958 New Scotland Rd. Rt. 85, across from Stonewell Plaza - Slingerlands • 439-5966



multi-speed • sales & service  
 268 Central Ave., Albany  
 434-1711

**VISTA DAWES BICYCLES**



Parts and Accessories For

All American and English Bikes

We repair all makes

**BENNETT'S**

561 Delaware Ave., Delmar  
 439-1862

**BLACKTOP**

**MARIAN'S BLACKTOP** driveways, garage floors, sidewalks. Also jennite sealer. 489-2780. tf  
**BLACKTOP DRIVEWAYS**, parking areas, sidewalks, garage floors. Free estimates. 482-5006 or 434-4920. tf

**DON MILLIOUS CONSTRUCTION**

Blacktopping & Excavation

Rt. 9W Selkirk, N.Y.  
 767-2100 767-9775

**CABINETMAKER**

FURNITURE REPAIR, bookcases, kitchen cabinets, picture frames. Vancans. 439-3541. tf

**CARPENTRY**

CARPENTRY, stairs, doors, windows, general repairs. Call 6-8 P.M. 756-2019. tf

CARPENTRY — MASONRY — Painting — Repairs — "No Job Too Small". Call Cliff 765-4289. tf

**ADDITIONS, GARAGES** — aluminum siding, roofing, paneling, playrooms, new homes, repairs, masonry. 439-1593. 4t1011

**COVENTRY, CARPENTRY**, cellar to roof, remodeling, kitchen, garages, additions. 439-6042. tf

CARPENTRY, GENERAL REPAIRS, additions, roofing, kitchens remodeled. 30 years experience. McAlister. 439-5742. tf

**HUBICKI — BAUM — SAGER**: Homes, garages, additions. Remodeling and general repairs. 756-9078. 3t920

**CARPET SHAMPOOING**

REILLY & SONS, carpet cleaning specialists, free estimates. Call 783-1137.

**CHILD CARE**

**MOTHER'S SHOP**, visit, take trips. Leave children at lovely country home, anytime 767-9537. tf

**BABY SITTING** — my home, week days, Unionville area. 439-6574. 4t913

**PLAYTIME** — 2-3-4 year olds, 10 A.M.-2 P.M., Tues. & Thursday, not a Nursery School, will supply lunch. 439-4422. 4t927

**SCREENED BABYSITTERS**

Overnight • Weekend • or Longer  
 University Family Services, Inc.  
 (Agency) • 456-0998

"Our Prices Are Reasonable"  
**LIUZZI BROS.**

Blacktop Specialists  
 Residential, Commercial,  
 Industrial — Fully Insured  
 Free estimate — 869-6973

**DRIVER TRAINING**

**ALL ALBANY AUTO ACADEMY**

66 No. Lake Ave., Albany  
 Beginners • Intermediates  
 Classroom Instruction Available  
**Tuesday, Thursday — 6 to 9**  
**Saturday — 9 to noon**  
**CARS AVAILABLE FOR ROAD TESTS**  
 Standard & Automatic  
 Call HO 2-1309

**ELECTRICAL CONTRACTORS**

**DUFFY ELECTRIC** — residential & commercial wiring — 24 hour emergency service. 439-5177. tf

**FURNITURE REFINISHED**

**EXPERT FURNITURE** refinishing. Drapes made to order. Also antiques for sale. Phone 766-4664. tf

**HORSES BOARDED**

**RING, JUMPS** — pastures; lessons English only; call 869-2482 or 482-0628. Roundabout Farm. tf

**JOSEPH'S TROUBADOUR STABLES**, riding lessons, pony rides. Training. Rt. 9W. 767-9537. tf

**INTERIOR DECORATING**

**INTERIOR DECORATING** — Delmar Decorators, Delaware Plaza, Call 439-4130. tf

**INSTRUCTION**

**VOICE LESSONS**: Gary Aldrich, who has sung extensively in our area, now giving voice lessons in Uelmar in conjunction wKaren Raring Studio. Details: 787-9585.

**PIANO LESSONS**

Beginners to Intermediates  
 For information contact  
**Julie Hauptman — 439-4569**  
 Winner of the Albany Concerto competition and League of Arts open competition

**PIANO LESSONS**

Experienced Teacher —  
 Classical —  
 Theory — Keyboard Harmony  
 For information call **439-0467**

**JEWELRY**

**EXPERT WATCH AND JEWELRY REPAIRS**. Diamond setting, engraving, wedding and engagement rings, reasonable. Your trusted jeweler. LeWanda, Delaware Plaza Shopping Center. HE 9-9665. tf

**NICKY'S LAWN SERVICE**  
 New Lawns — Landscaping  
 Trimming & General Clean-up  
 Free estimates • 370-3704

**LANDSCAPING**

**A-1 LANDSCAPING & LAWN SERVICE** — Spring Grooming, planting, thatching, seeding, sodding, tree service, grading, drainage, rototilling, etc. Private or Commercial. BankAmericard Welcome — **393-9045**.

**LAWNMOWERS**

**MEYERS**

**BICYCLE & LAWNMOWER**  
 Servicing Most Brands

**SNAPPER** Mowers & Tillers

Call now for  
**winter storage & repairs**  
 1958 NEW SCOTLAND RD., RT. 85  
 Slingerlands • 439-5966

**MASON WORK**

**EXPERIENCED**, all types masonry, new or repairs. Guidara. HE 9-1763 evenings. tf

**MASONS INC.**  
 QUALITY MASONRY

Fireplaces • Brick • Block  
 Plastering

A. Loux — 439-3434  
 R. Tice — 456-7848

**BLOCK FOUNDATIONS** — concrete floors, sidewalks, steps, garages, chimneys, patios, repairs, carpentry. 439-1593. 4t1011

**MOTORCYCLES**

**DAVE FLACH Sales & Service**  
 (formerly Blaisdell's)

The 1974's are here!  
 Triumph,  
 BSA, Rickman,  
 Hodaka &  
 Rupp  
 Motorcycles



Sales & Service & Parts  
 15 Main St., Ravena • 756-2911

**ORIENTAL RUGS**

**ALL SIZES AND Varieties** at importer's prices. New, used and antiques; washing and repairing; free decorator advice; new Colonie showroom; since 1925, Rustam K. Kermani Company, 1593C Central Ave., (1/2 mile west of Northway). 869-7829, 439-9419. tf

### PAINTING & PAPERHANGING

**VOGEL, PAINTING** Contractor, interior, exterior painting, paperhanging. Free estimates. Guaranteed. Insured. JIM HE 9-9718 or John HO 3-7162. tf

### BILL WRISTON



**PAINTING CONTRACTOR**  
• Fully Insured  
Residential Expert  
Paper Hanging  
459-2537 or 439-3166

PHONE  
785-3964  
Latham, N.Y.



PHONE  
439-9705  
Slingerlands, N.Y.

### SHAMROCK

**Painting & Maintenance Inc.**  
Interior • Exterior  
Paperhanging  
Free Estimates &  
Fully Insured  
Floor Finishing



### D.L. CHASE

**Painting Contractor**

**Residential Specialists**

Phone 768-2069



**BEAUTIFY AMERICA** with the  
**AMERICAN PAINTING CO.**

Interior • Exterior Painting  
Also Wallpapering

439-4834 • 434-1996

Free estimates, Satisfaction  
Guaranteed, Fully Insured

**EXTERIOR - INTERIOR** Painting, Paperhanging.  
Free estimates. Fully insured. 439-0413. 41104

### BOULEVARD DECORATORS

Specializing in custom made  
**REUPHOLSTERY**  
(10 day delivery)

### SLIP COVERS

Fabric or Plastic

### DRAPERIES

- Our own workrooms
- Fabrics in stock

**SHOP AT HOME**  
**FREE Decorator Service**

**472-9191**

BankAmericard - Master Charge

**PAINTING CONTRACTOR:** exterior, interior, paperhanging. Insured. Don Vogel. 489-7914, 434-8370. tf

### PERMANENT WAVING

**SPECIALIZING IN** Breck, Realistic Rayette and Caryl Richards permanents, hair tinting and bleaching. **MELE'S BEAUTY SALON.** Plaza Shopping Center. HE 9-4411. tf

### MOVERS

**D. L. MOVERS, INC.** 4395210. Local and long distance, no job too small. tf

### PIANO TUNING

**APPRAISALS - REPAIRS,** Roger DiNucci, 1368 N. Scotland Rd., Slingerlands. 439-2348. tf

### PLUMBING

### B. P. WOOD

**Plumbing & Heating**  
24 Hour Service  
**WATERLINE INSTALLATION**  
**SEWER INSTALLATION**  
**BACKHOE SERVICE**  
FULLY INSURED  
"NO JOB IS TOO SMALL"  
Phone 439-9454

**E & J PLUMBING** - no job too small, reliable, reasonable, experienced, call anytime, 439-6337, 767-9770. 411011

### ROOFING

**ASPHALT,** slate, wood shingle, ice slides, gutters, repairs Van Cans - 439-3541. tf

### M & V ROOFING

Glenmont  
ALL TYPES OF ROOFING  
Residential • Commercial  
All work guaranteed.  
463-5093

### ROOFING



Asphalt, Slate, Built-up, Wood Shingle, Gutters, Ice Slides, Repairs, Insured, Guaranteed.

FREE ESTIMATES  
**VANCANS**  
**439-3541**

### HELBO ROOFING

74 Bassett St., Albany, N.Y.

**465-2513**

All kinds of repairs & slate repairs, ice slides. **ALSO SNOW PLOWING.** Free estimates

### PRINTING & MAILING

**OFFSET PRINTING** - Mailing Service - Mimeographing, Typing, G. Bloodgood - Mimeograph Service, Delmar, N.Y. 439-3383. tf

**OLD FASHIONED SERVICE WITH KNOWLEDGE FOR BOTH BUYER AND SELLER**



**KLERSY-ROSS MLS REALTOR**

**A FULL SERVICE REAL ESTATE AGENCY**

282 Delaware Ave.  
Delmar  
439-7601

**THE TIRE STORE WITH A DIFFERENCE NASSAU TIRE CO.**

257 Delaware Ave.  
Delmar, N.Y.

DISTRIBUTORS OF  
**MOHAWK & BRIDGESTONE TIRES**  
439-0322

**CAPITOL**



has a fine selection of  
**USED DOMESTIC trade-ins**

Rt. 9W, Glenmont  
463-3141

Open Saturdays

### BLACK TOPPING

**Commercial & Residential TERMS ARRANGED**

Black our specialty  
All work guaranteed

Free est.: 434-4920 or 456-8121

### CAPITOL PAVING

146B CHURCH RD., ALBANY

### NEMER

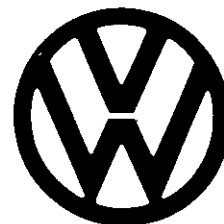

Rt. 7 West of Latham Circle  
Latham, N.Y. • 785-5581

**"IN OUR 53RD YEAR"**

*residential properties*

*appraisals*

*relocation services*

*land*

*new construction*

*guaranteed sales plan*

*commercial and industrial*

*division*



**REALTORS**

264 DELAWARE AVENUE, DELMAR • 439-9921

### HERBST AUTO BODY

327 Delaware Ave., Delmar  
(Behind Gochee Garage)

**Collision Specialists**  
Towing • Frame Straightening  
Body & Fender Repairs  
Painting • Insur. Adjustments

**439-4733 • 756-9405**

### H. J. STOTT & SON

**General Building Contractor**

Remodeling • Additions • Siding  
Roofing • Kitchens • New Homes

20 Years Experience

Fully Insured

**Free Estimates • 756-2939**

### FIREPLACE WOOD

**MIXED HARDWOODS:** \$18.00 face cord delivered.  
Shultes Brothers. 872-1495. 41104

**SEASONED FIREWOOD,** kindling, delivered. 459-  
8323, 235-1827. 111129

### PERSONALS

#### COMPANIONSHIP

Is this what you want or just  
a date for a social event? Call:

**Personalized Introduction  
Service • 767-2444**

### SEPTIC TANK SERVICE

**DELMAR SANITARY CLEANERS.** Service Tri-Village  
area over 20 years. HE 9-1412.

**NORMANSKILL SEPTIC TANK Cleaners.** We install  
dry wells, septic tanks, drain fields. 767-9287 tf

### SNOWMOBILE

#### Polaris & Brutanza

SALES & SERVICE  
CLOTHING & ACCESSORIES

**Get your machine  
ready for winter**

we service almost all makes

Do you need a new suit . . .  
boots . . . helmet? Pick yours  
while there's still a good se-  
lection.

#### SHEAR FARM COUNTRY STORE

Rt. 143, 4 mi. west of Ravena  
Open 7 days a week • 756-2314

## CARPET CLEANING SPECIAL

\$49.95 — LR, DR, HALL  
(up to 500 sq. ft. — stairs extra)

Gentle ServiceMASTER treat-  
ment cleans every fiber and  
restores original beauty and  
texture.

**ISN'T THIS THE DAY  
to call**

**SERVICEMASTER  
HOME SERVICE**

**869-3397**



# MARSHALL'S GARAGE, Inc.



ROUTE 9W, RAVENA

## INVITES YOU

### OPEN HOUSE — SEPTEMBER 25

### COME SEE THE 1974

### CHRYSLER CORPORATION CARS

### MAJOR CHANGES ON MOST MODELS

IMPERIAL

CHRYSLER

FURY

SATELLITE

VALIANT

SCAMP

DUSTER

Showroom Hours:

Mon.-Thurs. 8:00 A.M.-9:00 P.M.

Fri. & Sat. 8:00 A.M.-6:00 P.M.

ROUTE 9W  
RAVENA, N.Y.

756-6161

**SEWING MACHINE REPAIRS**

**SEWING MACHINE REPAIRED.** Work guaranteed. Delmar Decorators, 3 Delaware Plaza, Delmar. 439-4130. tf

**WELL KNOWN JOHN BESSON** repairs all makes of sewing machines, in your home, free estimates. Sells second hand sewing machines, guaranteed for one year. 463-2520. tf

**'3rd ESTIMATE'**

**ALLOW ME TO GIVE YOU YOUR "3RD ESTIMATE" FOR YOUR**

**ROOF**

Free Estimates • Fully Insured

- Customer Satisfaction Guaranteed •
- 25 Years Experience

**CALL TOM LAURICELLA — 756-6443**

**SCISSORS SHARPENED**

**SCISSORS SHARPENED** — also chain saws, garden tools, saws, knives, pinking shears, etc. 439-5156 or 439-3893. tf

**TRUCKING SERVICE**

**PIANOS, APPLIANCES,** light trucking. Call for free estimates. 456-3155. 711025

**WINDOW REPAIRS**

**GLASS AND SCREEN;** wood and aluminum — repaired and replaced. Roger Smith Paints, 253 Delaware Ave. — 439-4468. tf

**TELEVISION REPAIRS**

**MOTOROLA SALES & Service.** Jay's TV Service. 477-8675. 1911011

**TREE SERVICE**

**HERM'S TREE SERVICE.** Call IV 2-5231. tf

**BROWNIE'S TREE SERVICE** — tree stump removal. Insured. 456-7660, 456-3373. tf

**HERM'S TREE Service,** call IV 2-5231. tf

**TREESCAPE** — Arboricultural Services. 439-7147. H.C. MacIntosh, Prop. tf

**TABLE PADS**

**TABLE PADS** — made to order: Delmar Decorators — 439-4130. tf

**WATCH REPAIRING**

**EXPERT WATCH AND JEWELRY REPAIRS.** Diamond settings, engraving wedding and engagement rings, reasonable, your trusted jeweler, LeWanda, Delaware Plaza Shopping Center. HE 9-9665. tf

**WATCHES REPAIRING,** expert workmanship. All work guaranteed. Also engraving, diamond setting watch bands. Harry L. Brown, Jeweler, 4 Corners, Delmar. 439-2718. tf

**MERCHANDISE FOR SALE**

**IT'S TERRIFIC THE way** we're selling Blue Lustre to clean rugs and upholstery. Rent shampooer \$1. Delmar Lumber, 340 Delaware Ave., Delmar. tf

**LIQUIDATION SALE:** complete stock including fixtures. 25% to 75% off. All sales final, Gallagher's Ski & Sport Shop, 282 Delaware Ave., Delmar. tf

**KNAPP SHOES.** Cushioned comfort H. Russell Weiss, Glenmont 12077 465-6091. 201126

**TOMATOES.** Pick your own. Wellings, Johnston Rd., Westmere. 456-4631.

**SAXOPHONE:** Alto, Conn, excellent. Clarinet, fair. Sewing table, new. 439-5824.

**QUALITY TOP SOIL,** A. R. Vanderwood, Inc. 439-5222. 8t111

**WELL KEPT CARPETS** show the results of regular Blue Lustre spot cleaning. Rent electric shampooer \$1. Hilchie's American Hardware, 235 Delaware Ave., Delmar. 4t927

**FURNITURE**

Our low-cost operation policy enables us to bring you **BIG SAVINGS** on NEW furniture, rugs, bedding.

**BURRICK FURNITURE**

560 Delaware Ave., Albany

Just across the Thruway Bridge in Albany **465-5112**



**AMF SNOWBLOWER** — new, 8 H.P., two stage, 26 in., originally \$420.00, Now \$359.00. Joe Messina's Garage, Selkirk. 767-9971. 2t920

**HAND CREWEL** embroidered Chippendale wing chair, never used, cost \$285, will sell for \$225. Phone 438-5719 after 5 P.M. 2t920

**TRAILER FOR SALE:** 48x8 — 2 bedroom, living, kitchen, full bath, furn., lots of storage space on Saratoga Lake, can be moved, \$1200. HE 9-1605. 2t920

**PIANOS! ORGANS:** 150 in stock, Brown Piano Organ Mart. 459-5230. tf

**9 AREA RESIDENTS TO SERVE YOUR REAL ESTATE NEEDS**  
Call for fast, courteous action — 456-5101



**COHN • YAGUDA • CRONIN Realty, Inc.**

1648 Western Ave., Albany, N.Y.

Give to the  
American  
Cancer Society 

**TODAY'S THE DAY!**

**THE NEW 1974 FORDS & MERCURYS ARE ON DISPLAY**

**WE HAVE A GOOD SELECTION TO CHOOSE FROM and**

**YOUR BUSINESS IS APPRECIATED TODAY & EVERY DAY THROUGHOUT THE YEAR**

**Bud Kearney, Inc.**

**FORD — MERCURY**

Route 9W, Ravena, N.Y.  
Tel. 756-2105 • Open Evenings

**EXCELLENT:** cranberry wollen shag rug 12'x20'. 2 pairs cranberry crushed velvet drapes, 83" brown print quilted sofa, homespun brown chair with ottoman. Must sell by Oct. 1. 439-2644.

**COUNTRY SQUIRE** dark pine desk. Perfect condition, \$100. 439-2987.

**ZENITH 18"** black and white TV with stand. Excellent. \$65.00. 439-2987.

**DAVENPORT 68"** light grey sculptured nylon upholstery, new slip cover. \$75. 439-1260.

**HIDEABED,** piano, doghouse, typewriter; all cheap, after 5:00 439-4673.

**LARGE OLDER** Westinghouse electric range, very good condition, \$50.00. Rocking chair \$5.00. 439-4446.

**WOMAN'S PENDLETON SUIT** and sweater. Size 16. Asking \$40.00. 439-6629.

**GARAGE SALE:** Sept. 22nd, 10:00 A.M. to 4:00 P.M. (rain September 23rd). Antique chairs, clothes, size 10-12. Oriental rug with pad, 9'x12'. Storm windows, screens, dishes, appliances, misc. 54 Maple Avenue, Voorheesville, N.Y.

**BICYCLE, BOY'S** coaster brake, 26" wheel. \$12. 439-6152.

**HAMMOND ORGAN,** GE portable stereo, drum set, dog bed, fake fur jacket. 439-5203.

**TRUMPET** - Olds Ambassador, excellent, case, music stand, extra pieces. 439-5245.

**CURVED BENCH** Breakfast Nook, red formica table, large, reasonable. 438-5522.

**GOODYEAR RADIAL** snow tires 155 SR 13, used 1 season, \$40.00. Telephone 439-3529. 21927

**MEATLESS COOKING:** two cookbooks with really delicious meatless recipes at the Shuttle Hill Herb Shop, corner Delaware-Elsmere Avenues, behind Pharmacy.

**GARAGE SALE,** Sept. 22, 9:30-6:30, 14 Rita Court, off Orchard, corner Magdalen Rd., boys bicycle, ice skates, baby & household items, children's clothing, sizes 8 to 12.

**DINING ROOM SET,** Hoover Washer apt. size, 3 small rugs, floor lamp, coffee table, Chifonier, mirror, 2 electric cabinets, broiler, chrome bread box, Asst. kitchen utensils. 439-1277.

**GARAGE SALE** - Sept. 17 thru 21, moving, 9-5, 261 Elsmere Ave.

**FREEZER,** upright, 15 cu. ft. Admiral, good condition, \$150.00. 463-5345.

**TOMATOES,** 50 lbs., \$3.00 or \$1.00 lb. Butternut squash by the bushel. Vanderwood, Bender Lane. 462-4343.

**COAT, WOMEN'S** size 42, new, brown, mink collar, cost \$60.00, sell \$25.00. 439-1434.

**BOYS 28" BIKE,** Sears Spider 500. Like new, \$25.00. 439-5655.

**REFRIGERATOR,** kitchen set, pop-up camper, hard top, sleeps 8. 439-3709.

**FOR SALE:** GE dryer, needs new thermostat, \$10. 439-7557.

**GARAGE SALE,** household items, 115 Elm Avenue, Delmar, Friday, September 21, Saturday, 10-5.

**WHIRLPOOL REFRIGERATOR,** 15 cu. ft. \$50.00; ski boots, women's size 7, men's size 8. 439-0370 after 6:00 P.M.

**ELECTRIC RANGE 30"**, Frigidaire, good condition, \$100.00. 463-2401.

**HOUSEHOLD ITEMS:** garden & power tools, A-C tractor with mower, snowblower attachments. Small motors, bench and chain saws, old-fashioned wood high chair with pad, maple bed, vanity table, odds and ends. 463-1423.

**1970 NIMROD HARDTOP,** sleeps 6, excellent, \$750.00. 439-0322, 449-2771.

**BROWNING 5 SHOTGUN,** 12-gauge vent-rib. Like new, \$175.00. Deluxe French racing bike, \$175.00. 463-5130.

**LAWN SWEEPER,** power, self-propelled, like new, \$75. Snow blower \$35. Knabe spinet piano, excellent condition, \$400. 439-2306.

**GARAGE SALE:** 5 Furman Place off Kenwood - September 22 & 23rd, 10:00 A.M. to 4:00 P.M. Dryer, garbage disposal and more.

#### AUTOMOTIVE

Prevent **RUST** on new cars. **STOP RUST** on old cars. With our system, we **RUST-PROOF** complete under carriage, inside doors, inside rocker panels, inside trunk. **Appointment only.**

**JOE KELLER'S MOBIL**  
463-7712 • Rt. 9W • Glenmont, N.Y.

#### PETS

**LAST LONELY** Labrador puppy needs loving family. Big and cute. 756-9435 after 8.

## House of Pierre

We are dedicated to making your pet more beautiful.

Professional Grooming



239 DELAWARE AVENUE  
439-7907 or 439-1800

## DOGGIE DEN

**PROFESSIONAL GROOMING**

All Breeds

Free Pick Up & Delivery

485 Yates Street., Albany

• 482-9700 •

**LABRADOR RETRIEVERS,** 8 weeks, 2 black males, AKC, shots, great with children. After 6 weeks, 767-2170.

#### REAL ESTATE FOR RENT

**GLENMONT** - 1 bedroom, utilities, air-conditioned, heated garage, laundry facilities available, adults preferred, no pets, \$165.00. 463-2454.

**DELMAR:** immediate occupancy, furnished studio apartment and garage, ground floor. 439-3940.

**APARTMENT** - 2 bedrooms (opposite Elsmere Grade School), \$155.00 plus utilities, adults preferred. 439-9212.

**2nd FLOOR** - 5 room heated apartment. Hot water, electric stove, adults, no pets. Call between 10 A.M. or after 7 P.M. HE 9-1227. 21920

**STORAGE BUILDING:** 3200 sq. ft. Also garage space, Slingerlands. 439-1336. 21920

#### EXCITING NEW LISTING

## CLIFTON GARDENS

**IMMACULATE 3** bedroom 1 1/2 bath Colonial. White aluminum sided beauty on a well-kept freed lot. Family room, formal dining room and huge eat-in kitchen. With lots Aristocrat Cabinets. Dishwasher and disposal. Separate driven well for watering the lawn. In all respects, a great value at \$43,900.

#### ALSO SHOWING

**THREE BEDROOM** Colonial, family room, dining room, and big kitchen with dishwasher and self-clean oven. Brand new and ready for immediate occupancy. Special at \$39,700.

371-5331



#### WANTED TO BUY

**ELECTRIC TRAINS,** bought, sold, appraised. All makes, old or new. Call 273-8295 anytime. 41104

#### ROOM WITH BOARD

**PARENTS BOARDED;** lovely country home. Visit with them anytime. 767-9537. tf

#### HELP WANTED

**AVON CALLING** - buy or sell. Mrs. Calisto. ST 5-9857. tf

**EARN AT HOME** - Addressing envelopes and labels in your spare time. Send 25¢ and self-addressed envelope to I.S.R. Chase, Dover Plains, N.Y. 12522. 41920

**EARN AT HOME** addressing envelopes. \$800 monthly possible. Rush 25¢ and stamped addressed envelope to: M.A. FAUCHER, Dept. 17-Y, Box 493, Biddeford, Maine 04005. 31920

**HOUSEKEEPER** - 1 day per week, own transportation, salary open. 439-9518. 21920

#### HIGH SCHOOL STUDENTS

Earn extra money helping sell raffle tickets for the Tri-Village Nursery School Raffle. Kick-off meeting at the Bethlehem Coffee House, 125 Adams Place, on September 27, 1973 at 7:00 p.m. For additional information, call Mrs. Susan Ayers, 439-4757.

**MEDICAL SECRETARY** - busy office with good working conditions. Varied duties with considerable typing. 489-0119 after 6 P.M.

**HOUSEKEEPER** - 1 day weekly, Delmar, references. Call 439-7844 evenings. 21927

**SCHOOL AIDE,** Elsmere Elementary School, 10 month position, typing and ability to meet the public required. Call 439-1014.

**WANTED:** female general office assistant. Typing required. Apply in person or call 439-9943. Hilchie's American Hardware.

#### REAL ESTATE WANTED

**RETIRED COUPLE** desires one bedroom apartment, Tri-Village area. 439-7267.

**WORKING LADY** desires furnished studio apartment or room in Selkirk or area. Write Box 34, Selkirk, N.Y.

#### SITUATIONS WANTED

**WINDOWS CLEANED,** lawn care, repairs, driveways sealed, carpentry. McGraw 463-8882. 31927

**RIDE WANTED FROM** Route 144, Glenmont to 301 Washington Ave., Albany. Leave 8:15 to 4:15 return. Please call 462-3565. 21920

**BABYSITTING:** my home, 9W, Glenmont near Farm Family Insurance. 462-0626.

**SERVICE PROFITABLE** accounts in your area "Walt Disney Products" unusually high earnings. Inventory investment required \$3,290. Fully refundable. Income possibilities up to \$900 per month. Call collect Mr. Peters (214) 243-1981. 41104

#### LOST & FOUND

**LOST** - GREY female cat with white spot under neck. Winne & Louise St. 5 weeks ago. Reward. 439-2907.

**LOST: MONDAY A.M.,** male collie (sable with white markings), vicinity Maple Ave., Selkirk, named "DUKE". Reward. RD 7-3385.

767-2800 439-3349

**ELM AVENUE MOWER SHOP**  
Selkirk, N.Y.

"Authorized Factory Service"  
Lawnmowers and Snowblowers  
repaired and serviced

Winter and Summer Storage

Subscribe to The Spotlight

## OLD FASHIONED KNOWLEDGEABLE SERVICE FOR BOTH BUYER AND SELLER



**KLERSY-ROSS REALTY, INC.**

**REALTOR**

**Residential and Commercial Sales and Construction**

Appraisals and Competitive Market Appraisals

Multiple Listing Service

National Relocation Service

282 Delaware Ave.  
Delmar  
439-7601

A NUMBER IT PAYS TO CALL

## Inflation hasn't changed the price of ashes.

But it has changed the price of your home. For example, if you bought a \$20,000 home in 1968—today it's worth about \$27,000. Don't be left with a costly pile of ashes. See me about a State Farm Homeowners Policy that will cover your home for all it's worth... and keep it that way with automatic Inflation Coverage.

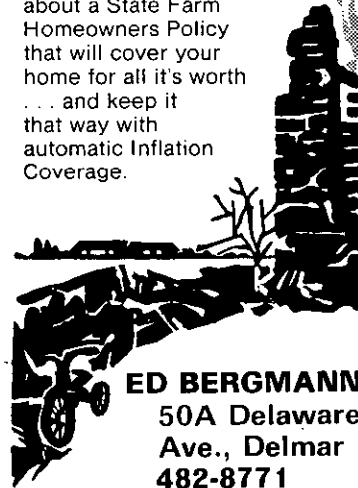

**ED BERGMANN**  
50A Delaware Ave., Delmar  
482-8771



**STATE FARM**  
Fire and Casualty Company  
Home Office:  
Bloomington, Illinois



LeVere L. Fuller

# Wandering & Wondering . . .

OUR PICTURE EDITORIAL about the inadequate drains at the underpass on Elsmere Avenue caused a stir, as witness this letter:

Dear Mr. Fuller:

I most emphatically take exception to part of your Picture Editorial in the September 6, 1973 issue of the Spotlight, the part in which you refer to the Police Dept., Auxiliary Police, etc.

On that Friday evening I had just returned from Dover, Delaware about ten minutes before the storm hit. After letting things settled in the house I noticed some activity in the corner of Herber & Elsmere Avenues (three houses away) so I went down there. On arrival I saw a car being towed out of the water from under the railroad bridge, and was told by a neighbor that the car had been knocked into the water by the car behind it whose brakes failed from being wet.

Being a member of the Auxiliary Police (though not acting in that capacity as we had not been called out) I took over the task of diverting the traffic from the underpass. There was at that time flares in the road and traffic cones from the Elsmere Fire Dept. blocking the road to the underpass.

(Continued)



*Applebee*  
*Funeral Home*

*Inc.*

403 Kenwood Avenue  
Delmar, New York

*Jacoba P. Applebee, Lic. Dir.*



## COME ONE — — — COME ALL



### SEPTEMBER 23rd

# ANNUAL FAMILY PICNIC

2:00 P.M. - 6:00 P.M.

Sponsored proudly by the

Men's & Women's Republican Club of Bethlehem

SUNNY ACRES DAY CAMP, Elm Ave. Ext., Selkirk



Bethlehem Volunteer Firemen  
Round Robin Softball Tournament

GAMES

COTTON CANDY

## MEET YOUR REPUBLICAN

## CANDIDATES

## REFRESHMENTS

## WANDERING & WONDERING (continued)

I sent my nephew back to my car for my orange raincoat and more flares and I was at that intersection for over two hours diverting traffic until the flood water receded. While there, I could see a Bethlehem Police Car and at least eight flares lit and constantly replaced, on the Delaware Ave. side of the underpass. However, in spite of a man, flares and traffic cones, I had motorists drive over the flares and argue why they couldn't drive through.

You state in one paragraph that "the roads were hazardous both because of the flooding and wind-felled trees and tree limbs" (you forgot to also mention power lines down) and in another paragraph dealing with the underpass you ask "Where were the Police?" They were very busy taking care of the roads that were hazardous from

the trees and power lines, and policing other related emergency situations. Twice, while I was diverting traffic away from the flood water, the Police on their way to other calls stopped to ask if I was all right and if I needed anything.

I feel we have a damn good Police Dept. in the Town of Bethlehem, and think they should be complimented for their work rather than knocked.

Very truly yours,  
John C. Rapp

We will go along with most of Mr. Rapp's letter — except where he is in error. Let's take them one at a time.

The point of disagreement centers on one word: time. When Mr. Rapp arrived on the scene, three cars had already been victims of the flooded area. This first one had been towed away before the next two hit the water — and at this time, there were no cones, no flares — and no police. We did not say that no one showed up. We said that there was no warning until after three cars had been victims. The difference here being that the police **knew** of this hazard and therefore should have been of immediate concern. Power lines and trees must necessarily be reported because there is no way of telling where they'll come down — but during the past 35 years, Elsmere Avenue underpass hasn't moved an inch — and it has been a continual hazard.

(Continued)

### VACATION OVER?

Bring your Angel to



### The Heavenly Inn

1903 New Scotland Rd.  
Slingerlands, New York

Relaxed dining  
Reservations 439-9874

Superb Cocktails  
Open Wed. thru Sun.



*Hey Gals!*  
*for full Nutrition*

**BUY**

*Freikofer's*

**BATTER-WHIPPED**  
**SUNBEAM BREAD**

**Available Almost Everywhere**

ANOTHER LETTER RECEIVED this week was written by Al Kellert and is directed to the many, many area bike riders:

Dear Mr. Fuller,

Do you like "Get Well Cards?" Or perhaps, if you try real hard, you might even earn a sympathy card for your family. There is a guaranteed manner in which anyone can get: one or two broken arms, one or two broken legs, a broken neck or a broken back, a ride in an ambulance, a room in a hospital, a doctor, a nurse, a cast, tons of pain and suffering.

Here are the simple rules. First you must be a BIKE rider, must own a BIKE and be extremely careless how you handle your BIKE. For example, barrel out of the driveway as fast as possible. If you do not have a driveway, then pedal quickly as possible from whatever starting point you choose. When you enter the street, road or highway, never, never look left or right to check traffic. Just keep going, preferably with eyes closed.

Once on the highway: ignore all traffic lights, stop signs at intersections and always ride your BIKE on the wrong side of the road even if you know where the right side is "Hiding" out of sight.

Race as often as possible with other friendly BIKERS, especially down-hill. While engaging in this fascinating sport, try "No Hands." That's cool, man. And a real winner.

Be absolutely certain your BIKE does not have a rear reflector, a front light, a horn or good brakes. Especially good brakes.

If you see a car or truck coming at you or behind you, pay no attention to that vehicle. Just close your eyes and pump away. The point is to keep going without precaution.

Never ride your BIKE slowly. That would take the fun out of BIKING, would protect your health and well being, would give you a good muscle-buildup and most important of all would keep your BIKE under control. Who needs it?

Try to hit a few pedestrians now and then. That's great sport and a good way to test the ability of your BIKE to withstand a face-to-face confrontation with human flesh. You might even be lucky and send an elderly person to the hospital. Of course, the sidewalk, where BIKES don't belong, would be a good hunting ground.

Never, never allow a car or truck to pass you. Always zig zag in and out in front of the vehicle. That's great fun and always irritates the operator of the vehicle. He should not be on the road anyway.

Look for rocks, wood, bumps on the street or in the road. Try to hit'em or run over'em. This is always sure-fire sport and usually throws you off the BIKE, on the pavement and may even render you unconscious.

Leave your BIKE anywhere, anytime and never, never lock it securely. You might get lucky, lose it to a quick thief and in that case you'll never make the hospital in the first place.

Al Kellert

## community corner

### HOW GOOD A SHOT ARE YOU?

**What:** National Hunting and Fishing Day Celebration.

**Where:** Bethlehem Sportsmen's Club, Rte. 443 to Cass Hill Road, just west of Clarksville.

**When:** Starts at 10 A.M., Saturday, September 22.

Youngsters who attend this Celebration sponsored by the Bethlehem Sportsmen's Club will have a full day of shooting and archery contests with afternoon demonstrations by professional conservationists and skilled amateurs. Plus a hunter safety program. You may bring your lunch or purchase it at the Club. There'll also be a pie eating contest, log rolling and fun, fun, fun!

### IT'S GUARANTEED GOOD EATING!

**What:** New Scotland Kiwanis Club Annual Chicken Bar-B-Q.

**Where:** New Scotland Presbyterian Church, Rte. 85, New Scotland.

**When:** 4-8 P.M., Saturday, September 22.  
Take-out orders: call 439-6465 after 4 P.M.

This is one of the famous area Bar-B-Qs with a solid reputation for high quality, excellently-prepared food. The proceeds are earmarked for famous use, too: community services and youth activities. The cost: adults, \$3.75, children under 10, \$1.75 for a complete dinner and dessert.

Community Corner, a public service column of important community events, is sponsored by the people of the

PLASTICS DEPARTMENT  
**GENERAL  ELECTRIC**  
SELKIRK, NEW YORK 12158

# Sears

We  
Make  
House  
Calls!

Get free  
decorating  
help from Sears  
Custom Shop  
... with no  
obligation.

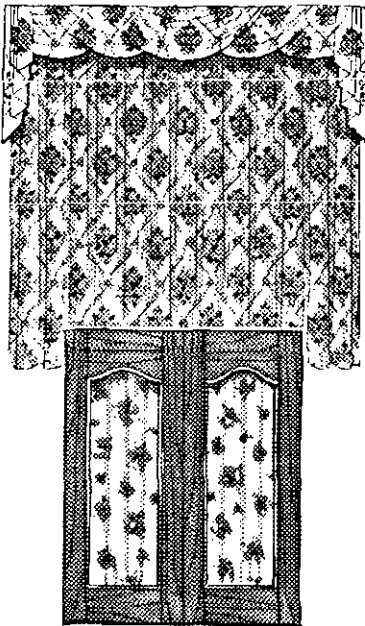
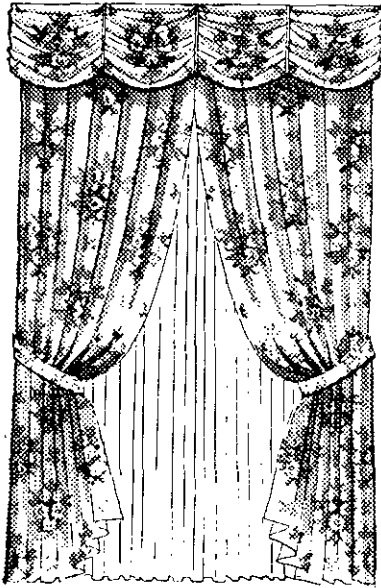

Professional  
salespeople will  
show you fabric  
samples and idea  
books for all your  
window decorating  
and reupholstery needs.

All work is  
individually tailored  
and carefully  
installed. And you  
can depend on Sears  
to see that you  
are satisfied with  
your purchase.

*Charge It On Sears  
Revolving Charge*

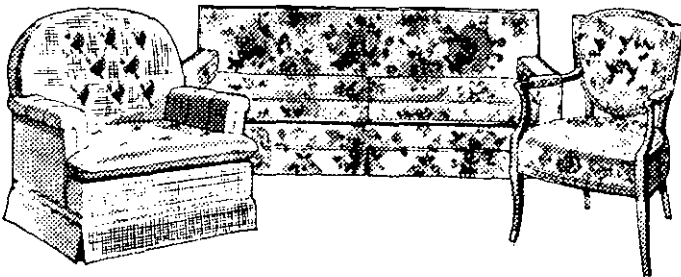

*Satisfaction Guaranteed or Your Money Back*

SHOP AT SEARS  
AND SAVE

**Sears**

COLONIE CENTER  
Wolf Rd. at Rt. 5

SEARS, ROEBUCK AND CO. 459-8100

# TREESCAPE

## ARBORICULTURAL SERVICES

EMERGENCY SERVICE ANYTIME  
ANY WEATHER

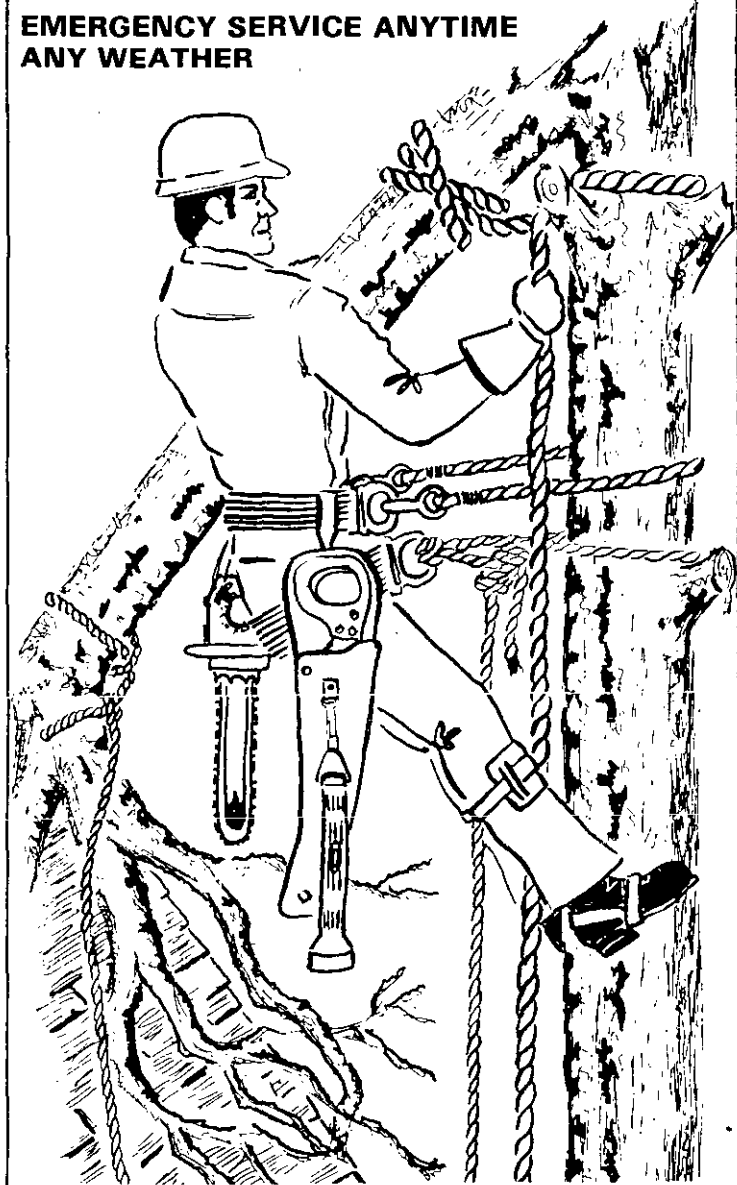

**H.C. MacINTOSH 439-7147**

BOX 14, SLINGERLANDS, N.Y. 12159

DEL MAR, NEW YORK 12054  
14 WEL LINGTON ROAD  
MR. CHARLES J. KATZ

