

The Spotlight

SEPTEMBER 12, 1974
VOL. XIX, NO. 37

Controlled Circulation Publication

20¢

GREENBERG

COUNTRY FAIR '74

BENEFIT

**MOUNT HOLYOKE COLLEGE
ALUMNAE SCHOLAR PLAN**

COME - SAT. SEPT. 14 *Even or Share*

TO - the **BARN** at **GREENBERG'S**
Krumkill Road, Slingerlands

STAY - 11:00 a. m. 'til **DUSK**

ENJOY - a **DAY** of **FAMILY FUN**

HARVEST FARE

Bake Sale
Country Picnic
Produce
House Plants

ANTIQUES

FLEA MARKET
CRAFT BOUTIQUE
ART SHOW & SALE

Raffles and Prizes

COMPLETE CLOSE OUT SALE ON ALL RCA 74 MODELS

RCA
The PROJECTA 17
Model ES396
17" diagonal picture

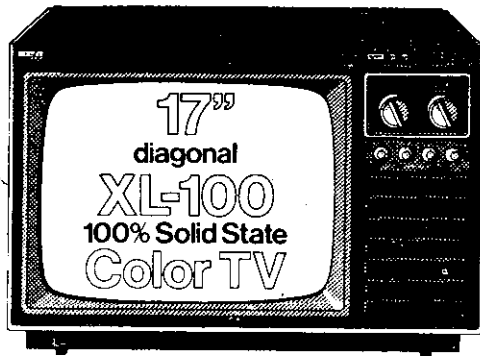

- RCA's new AccuLine picture tube system in a deluxe cabinet that'll flatter any room! Brand new type of black matrix picture tube delivers a new level of brightness and detail, with permanently aligned dynamic convergence.

GET BOTH!

**The Miracle of 100%
Solid State Circuitry
& Great Styling!**

- AccuMatic IV brings color, tint, brightness and contrast within a normal pre-set range at the touch of a button.
- Automatic Fine Tuning electronically pinpoints and accurately holds the correct picture signal on each channel.



RCA
The TERANO
Model FS488
19" diagonal picture

- Many people love Spanish style furniture, but lack space for a big TV console. The Terano's the answer. Only 27½" wide, with an optional matching base that moves easily on hidden casters.

FALL HOURS

Mon, Wed, Fri. 10 - 6

Tues, Thurs. 10 - 9

Sat. 9:30 - 5

BOB Sowers'

**We Service What We Sell
Delmar Appliances**

239 Delaware Avenue, Delmar

439-6723

Spotlight

is published every Thursday by Spotlight, Inc., 154 Delaware Ave., Delmar, N.Y. 12054, Robert G. King, Publisher; Mrs. LeVere L. Fuller and Joni Judware, Editors. (Controlled Circulation, Postage Paid at Delmar, N.Y.) Deadline for news is Thursday afternoon, one week preceding publication; deadline for display and classified advertisements is Friday afternoon.



... NOW OPEN TO THE PUBLIC ...
 Specializing in Banquet Facilities for Special Events
 Call: Mrs. Robilotto, 439-3392 for Reservations
Tall Timber Country Club
 Hilton Road, Slingerlands

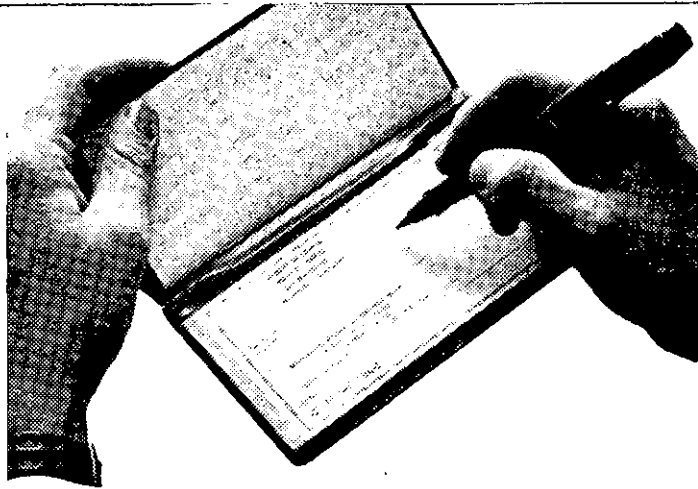

Senior Citizens...

**Free Payment Orders,
 NOW from
 the ME Bank.**

Now, free to senior citizens (Over 62)—or anyone on Social Security—you can get all the payment orders you need for buying things and paying bills. No minimum deposit. No minimum balance. No monthly service charge.

We suggest you bring your Social Security check to any ME Bank office and open a non-interest bearing "Pay Now" account. (In due time the Treasury Department expects to make it possible for you to have your Social Security check mailed directly to the ME Bank.) Also, for additional security, open a companion "Save Now" account, currently earning 5% interest compounded daily. With both "Pay Now" and "Save Now" accounts the ME Bank will send you monthly statements so you'll have complete records. Stop in at any of our seven offices, NOW!

There will be a fee of \$3.00 for any item returned for insufficient or uncollected funds; and \$2.00 fee for any stop payment request. No overdraft shall be permitted.



**mechanics
 exchange
 savings
 bank**

Member Federal Deposit Insurance Corporation

Albany Saratoga Cobleskill Oneonta Phone (518) 436-0811

HANDY HUT CERAMICS

ROUTE 9W and BEACON ROAD
 GLENMONT, N.Y.

Register now for fall classes.
 MORNING OR EVENING — \$1.50 per class

449-8795

SALE PLACE MATS

STRAW WOVEN
 FIBRE ABACA

25% OFF

**HUNDREDS TO
 CHOOSE FROM**

**COME EARLY FOR
 BEST SELECTION**

The Village Shop

DELAWARE PLAZA

Daily 10 A.M.

Evgs. Tues. thru Fri.

An exhibit of archaeology from the Quackenbush House

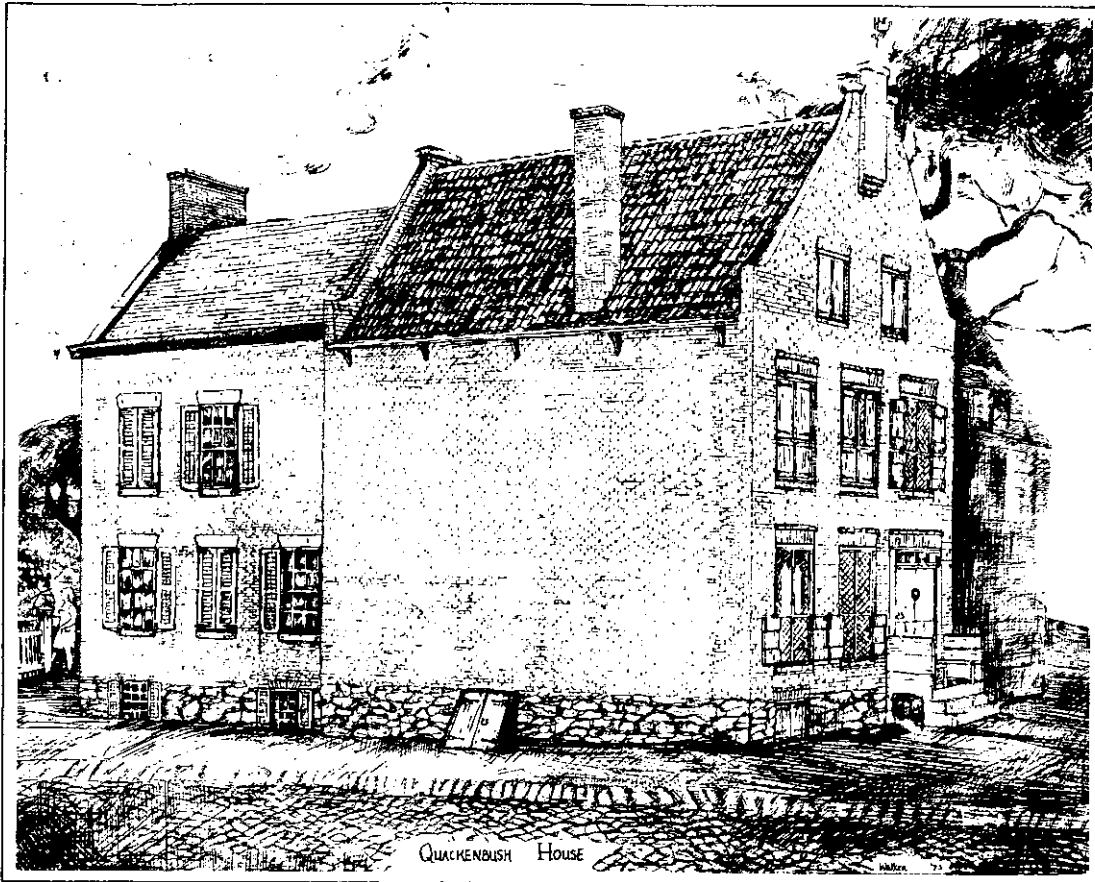

In the summer of 1972, salvage work began at the "oldest extant structure in Albany, one of the few Dutch urban buildings in America" . . . the Quackenbush House, at the corner of Clinton Avenue and Broadway. Since then, hundreds of artifacts have been unearthed at the site. Among these are clay pipes dating from 1800-1860, pieces of plates, pitchers, and serving dishes made of Delft, Creamware, Red Slipware and White Salt-Glazed Stoneware, bottles, an axe head, flint arrowheads.

Some of these artifacts are now displayed in the lobby of National Savings Bank's downtown Albany office at 90 State Street. Color prints of paintings by De Hooch and Vermeer show ceramic items — similar material has been found at Quackenbush House — in use in Holland. There's a replica of a colonial land development map of the Albany-Rensselaer area, and a display of clay pipes and other artifacts.

Come in and spend a little time reliving Albany's beginnings.

Exhibit courtesy of Bureau of Cultural Affairs, R. W. Arnold III, Director, Department of Human Resources, John J. McEneny, Commissioner, City of Albany.

 **NATIONAL
SAVINGS BANK**

MAIN OFFICE: State & Pearl Streets, Albany

BRANCHES: Westgate Shopping Center
Route 50, just east of Northway

MEMBER FDIC Exit 15, Saratoga Springs
30 Brinkerhoff Street, Plattsburgh

Spotlight CALENDAR

Tri-Village FISH — Call 439-3578 for voluntary service — 24 hours a day the year 'round — offered by residents of Delmar, Elsmere and Slingerlands to their neighbors in need of help in any emergency.

Bethlehem Jaycees meet first and third Wednesdays of the month, 8 P.M., Center Inn, 9W, Glenmont.

Welcome Wagon — Newcomers and mothers of new babies call 785-9640, Mon. thru Sat., 8:30 A.M.-6:00 P.M. so you may have a Welcome Wagon call.

Bethlehem Memorial Auxiliary to Post #3185, Veterans of Foreign Wars, meets the third Monday of every month, at the Post Rooms, 404 Delaware Ave., Delmar.

The Albany County Pistol Club, Winne Place and Maewin Drive, Delmar, welcomes guests, at its indoor pistol range every Tuesday at 8 P.M. Information: Dave Herbach, 439-4372 or Tom Corrigan, 439-3301.

Monarch Club of Albany meets every Tuesday night at 6 at the Center Inn, Glenmont.

Give and Take Shop, staffed and stocked by residents of Delmar, clothing for all occasions, all ages, all sizes, available to everyone. Basement St. Thomas Apostle Church & Rectory), Mon. 9:30-11:30 A.M., Tues. 1-3 P.M., Sat. 10 A.M.-12 Noon.

Every Thursday at 7 P.M., Delmar Reformed Church, scout meeting for handicapped, Troop 159.

Kiwanis Club of Delmar meets every Monday night at 6:15 at The Center Inn, Route 9W, Glenmont.

Bethlehem Lions Club meets 1st and 3rd Wednesdays of the month at The Center Inn, Route 9W, Glenmont, 6:30 P.M.

AARP meets 1:30 P.M., third Tuesday of month, Delmar First United Methodist Church, Kenwood Avenue, Delmar.

The Delmar Community Orchestra rehearses every Monday evening from 8 to 10 at the First United Methodist Church of Delmar.

Bethlehem Junior Woman's Club meets 2nd Wednesday of each month, 8 P.M., Bethlehem Public Library.

Bethlehem Recycling Program (paper, cans, glass), Town Garage, 114 Adams St., Delmar. Mon. thru Fri., 8 A.M.-4 P.M. Papers should

be tied, cans flattened, bottles clean w/metal removed.

Rosary — St. Thomas Church, Adams Place, Delmar, every Thursday at 11:45 A.M.

Nathaniel Adams Blanchard Post #1040, American Legion Auxiliary, meets third Tuesday of month except July & Aug., 8 P.M., Post rooms.

Nathaniel Adams Blanchard Post #1040, American Legion, meets first and third Monday of month (when holiday occurs, move to Tuesday) except July and August. 8:30 P.M.

8:15 P.M., meeting, every Wednesday, Gam-Anon, wives of compulsive gamblers, St. Pius Church, Loudonville. 462-6916 or P.O. Box 23, Albany.

Onesquethaw O.E.S. meets on the first and third Wednesday of every month at the Masonic Temple in Delmar.

Glenmont Lions Club meets 2nd and 4th Wednesdays of the month at LaCasa Restaurant, Selkirk, 6:30

P.M. Visitors welcome. Info: Bob Jones, 463-3141.

Glenmont Homemakers meet 3rd Wed. of month; Glenmont Comm. Church, 8 P.M.

8 P.M., monthly meeting, last Thursday of each month, Elsmere Fire Co.

L.E.A. Nursery School, now accepting fall registrations, '74-'75 session, 3 and 4 year olds. Contact: Mrs. Boykin, 463-0512, Mrs. Denison, 439-4019 after 5:30 P.M.

1-5 P.M., Trap Shooting, Bethlehem Sportsman's Club, Dunbar Hollow Road, Clarksville, every Sunday starting May 5, free instructions noon to 1 p.m. and every Wed., 7 P.M. starting June 5. Non-members welcome. More information: 439-6003.

Bethlehem Lodge meets on 1st and 3rd Wednesday of every month, Ladies' Auxiliary meets on 2nd Wednesday of every month.

Clam Chowder on sale 3rd Friday of each month through September. New Salem Reformed Church, Rt.

85, New Salem. 12-4 P.M. Bring container.

Bethlehem Youth Employment Service, 114 Adams Street, Delmar. School year schedule, Monday-Friday, 1:00-4:30 P.M. Telephone 439-2238.

Bethlehem Museum, Rt. 144 and Clapper Rd., featuring "Ladies' Fashions 1870-1910" every Sunday through August 4, 2:00-5:00 P.M.

Tri-Village Nursery School is now accepting applications for September enrollment. Call 439-3102.

Registrations — St. Thomas School, all grades except 5 & 6. Call 439-1285 or stop at Convent.

Bethlehem Museum, Rt. 144 and Clapper Road featuring "Children's Toys — Dolls and Their Houses," every Sunday through Oct. 20th, 2:00-5:00 P.M.

THURSDAY, SEPTEMBER 12

8 P.M., meeting, Ladies' Auxiliary of Delmar Fire Dept. at Fire Hall.

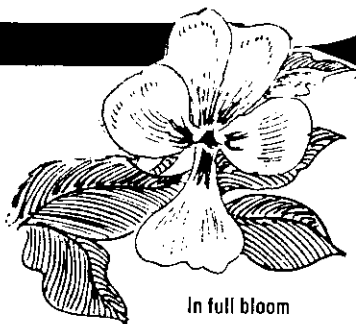

In full bloom

Sat., Sept. 14
GLENMONT
Store Only

FREE AFRICAN VIOLETS

TO HELP CELEBRATE OUR NEW GREENHOUSE, SCOTT'S IS GIVING AWAY FREE TO EACH ADULT A BEAUTIFUL AFRICAN VIOLET. JUST VISIT OUR SCOTT'S DISPLAY AND PICK ONE UP, THIS SATURDAY ONLY. (LIMIT FIRST 300 CUSTOMERS)

LAWNLOVER SPECIAL



Scott's®
Turf Builder®

America's favorite lawn food

\$2 off 15,000 sq ft

\$1.50 off 10,000 sq ft

\$1 off 5,000 sq ft

LAWN PROBLEMS??

A SCOTT'S REPRESENTATIVE WILL BE IN OUR GLENMONT STORE SAT., SEPT. 14 — BRING IN YOUR LAWN QUESTIONS.

TWO GREAT LOCATIONS

GLENMONT
FEURA BUSH RD.
439-1835

GUILDERLAND
Rt. 146 — Albany Carman Rd.
356-0442

WIN \$100.00
SHOPPING SPREE
IN OUR GLENMONT STORE
DEPOSIT COUPON AT OUR SCOTT'S DISPLAY
DRAWING SATURDAY, SEPTEMBER 14, 1974

GARDEN SHOPPE — \$100 SHOPPING SPREE
Saturday — September 14, 1974

Name

Address

City..... Phone

Garden Shoppe

Daily 'til 6, Sat. 'til 5, Sun. 10-4



*Come bank in our parlor... our living room...
our dining room.*

We're having a Bankwarming, and You're invited.

Good News... Fidelity Bank has come to Bethlehem. While our house is only temporary quarters until our new building is completed, we're bringing our new neighbors all the great banking services we've provided for the people of Colonie and Albany for almost 9 years.

Like any new neighbor, we hope to meet all the folks in Bethlehem,

and we'd like you to feel right at home with us. So, we're open Monday through Friday from 10 AM until 6 PM, and, for your added convenience, Saturday from 10 AM until 1 PM. We call these "customers' hours."

Come see us at 354 Delaware Avenue. The door's open, and we'll be in the parlor.



Fidelity Bank

AND TRUST COMPANY

A MANUFACTURERS HANOVER AFFILIATE

MEMBER FDIC



THURSDAY, SEPTEMBER 12

9:30 A.M., Coffee, League of Women Voters, get acquainted, Bethlehem Public Library. 439-4266 or 439-2210.

8 P.M., meeting, Elsmere Fire Company Auxiliary. Everyone requested to bring a plant for plant auction.

8 P.M., meeting, Albany Central LaLeche League at home of Mrs. Robert Bray, 31 Crescent Drive North. Information, contact Mrs. Mills.

7:30 P.M., Bethlehem Art Association Slide Show, Bethlehem Public Library.

7 P.M., Mini-lessons, help consumer's beat inflation, sponsored by cooperative extension at Extension Center, Voorheesville. Register by 6th, 765-2874.

FRIDAY, SEPTEMBER 13

Inservice Day Program, B.C. School District teachers, no school for students.

SATURDAY, SEPTEMBER 14

10 A.M., Westerlo Reform Church sponsors annual fair & auction, donations: 797-3439 or 966-8561.

7:30 P.M., "Polish Nite," Voorheesville American Legion, at Legion Hall, free beer, dinner 7:30. Tickets \$6.50, 765-9387.

Lord's Acre Auction, Fair and Chicken Barbeque, Trinity United Methodist Church, Rte. 143, Coeymans Hollow.

11 A.M.-5 P.M., Country Fair, grounds of Greenberg Home, Krumkill Rd., Slingerlands.

10 A.M.-12 P.M., 3rd Action Auction, Christ Lutheran Church, 1500 Western Ave., Albany.

10 A.M.-2 P.M., Paper Drive, First United Methodist Church. Youth Fellowship. Bring papers to Town Parking Lot. Pick-up: 439-9976 between 9:00 A.M. and 12 Noon.

SUNDAY, SEPTEMBER 15

7 P.M., Movie, "To Russia With Love," Bethlehem Community Church, 201 Elm Ave., Delmar.

12 Noon, Field Day, Riverside Volunteer Ambulance Squad, at Ganser-Smith Memorial Park (Menands Ballpark), Menands Rd., Menands.

MONDAY, SEPTEMBER 16

6:30-9:30 P.M., First Aid Class, Bethlehem Middle School, 8 weeks, 462-7461, American Red Cross.

TUESDAY, SEPTEMBER 17

12:30 P.M., meeting, Bethlehem Tri-Village Chapter American Association of Retired Persons, United Methodist Church, Delmar.

WEDNESDAY, SEPTEMBER 18

8 P.M., Coffee, Bethlehem Junior Woman's Club, home of Mrs. Clay-

DELMAR STORE NOW RE-OPENED

FRAIM'S HOUSE of CARPETS SHOWROOM AND WAREHOUSE

1009 CENTRAL AVE., ALBANY, N.Y. 243 DELAWARE AVE., DELMAR, N.Y.

482-8879

Mon. & Wed. — 10:00-5:30
Tues., Thurs., Fri. — 10:00-9:00
Saturdays — 10:00-5:30

439-9979

Mon.-Fri. — 10:00-5:00
Wednesdays — 7:00-9:00
Saturdays — 10:00-3:00

NOW OPEN DON AVERILL'S Cocktail Lounge

OPEN DAILY 11 a.m. to 4 a.m.
SUNDAY 1 p.m. to 4 a.m.

Sandwiches served until 2:30 a.m.

All legal Beverages

FEATURING

Frankie Brown Trio
THURS.-FRI.-SAT.

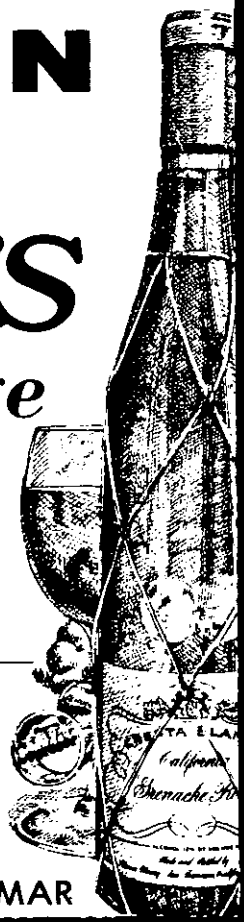

99 DELAWARE AVE.

DELMAR

PICK YOUR OWN

MacIntosh Apples

Sept. 14 & 15, from 9-5

We are now pressing

CIDER

Bartlett Pears



2 miles W. Voorheesville
on Rt. 156 • 765-2956
9-6 Weekdays • 10-6 Sundays

WE ARE NOW BAKING:

Old Fashioned Apple Pies

Hot Cider Doughnuts

Fresh Bread

C. B. CLARKE, INC.
FOR
INSURANCE
CALL



Burt Anthony

**AUTO INSURANCE RATES
GOT YOU DOWN? CALL THE
GOOD GUYS AT THE CLARKE
AGENCY AND COMPARE!**

439-9958

339 Delaware Ave.
Delmar



ton Kass, 33 Surrey Mall, Slingerlands. Ages 20-40 invited.

7:30 P.M., Lesson on recycled furniture, Cooperative Extension, at Extension Center, Voorheesville. Register by 13th, 765-2874.

THURSDAY, SEPTEMBER 19

10 A.M., Get-Acquainted Coffee, Slingerlands P.T.A., school library.

7:30 P.M., meeting, Glenmont P.T.A. Everyone invited.

SUNDAY, SEPTEMBER 22

7-8 P.M., meeting, United Methodist Women, Delmar Methodist Church.

TUESDAY, SEPTEMBER 24

7:30-8 P.M., meeting, Bethlehem Women's Republican Club, at the Bank.

WEDNESDAY, SEPTEMBER 25

8 P.M., B.C. Board of Education meeting, Educational Services Center, 90 Adams Pl., Delmar. Public invited.

CHURCH DIRECTORY

FIRST REFORMED CHURCH OF BETHLEHEM

Route 9W, Selkirk

Parsonage & Study Phone
— 767-3406

Office Phone — 767-2243

Staff

Jack Hilbrands, B.D. Pastor

Mrs. Marlin Fuller Organist & Choir Director

Mrs. John DeYoe
Church School Superintendent

Sunday School — 9:30 A.M.

Sunday Worship — 11:00 A.M.

Youth Meeting — 7:00 P.M.

FIRST UNITED METHODIST CHURCH

Sunday Morning Worship & Church School 9:15 & 11:00

Pastors:

Robert B. Thomas

Thomas D. Peterson

Sang Hahn

DELMAR REFORMED CHURCH (Founded 1841)

386 Delaware Ave., Delmar, N.Y.

Worship & Church School 10 A.M.
Crib & Nursery Care 10 to 11 A.M.

See Us...

For All Of Your Back To School Needs.

BACK TO SCHOOL SPECIAL...

LINDY PACESETTER
BALL PENS

20¢

Reg. 59¢

C. M. GROVER - STATIONERS

Commercial and Social Stationery

20 Delaware Plaza Delmar, N.Y. (518) 439-4475

Coffee Fellowship 11 A.M.
Youth Groups 7:00 P.M.

Pastors
Gerard J. Van Heest
David L. Cooper

GLENMONT COMMUNITY CHURCH (Reformed)
3 Weiser St., Glenmont

Rev. Jack Cooper, Pastor

10 A.M. — Worship Service
11:15 A.M. — Sunday School
Everyone Welcome
("Coffee and ..." after service)

FIRST CHURCH OF CHRIST, SCIENTIST

555 Delaware Ave., Delmar
439-2512

Sunday Services at 11 A.M.
Sunday School also at 11 A.M. for
those under the age of 20

Wed. Testimony Meetings 8 P.M.

Reading Room at
397 Kenwood Avenue
Daily except Sun. and holidays
11:30-4:00

Everyone Welcome!

BETHLEHEM LUTHERAN CHURCH

85 Elm Ave., Delmar

Rev. Paul H. Gassmann

9:10 A.M. Sunday School & Bible
Classes

10:00 A.M. Coffee Hour

10:30 A.M. Worship Service (Nur-
sery)

1st & 3rd Sundays — Communion

**FIRST UNITARIAN CHURCH
of ALBANY**

405 Washington Ave., Albany

The Rev. Nick Cardell, Jr.
Office phone: 463-7135

10:30 A.M. — Sunday Service and
Church School
11:30 A.M. — Coffee Fellowship

BETHLEHEM COMMUNITY CHURCH

201 Elm Avenue, Delmar
439-9492

Sunday School — 9:30 A.M.
(Infants through Adults)
Morning Worship — 11 A.M.
Evening Fellowship — 7:00 P.M.
Prayer Service — Weds. 7:15 P.M.

Youth Activities
throughout the week

David P. McDowell — Pastor

CLARKSVILLE COMMUNITY CHURCH (Reformed)

Worship and Sunday School
10 A.M.

Coffee & Fellowship Following
Rev. Melchior Van Hattem, Pastor
768-2016

DELMAR PRESBYTERIAN CHURCH

585 Delaware Avenue
Delmar, New York
439-9252

Summer Worship and Nursery Care
— 10:00
(July 7 to September 8)

JETZON TIRES

**JONES SERVICE
(BUD)**

QUAKER
STATE OIL

14 GROVE STREET, DELMAR

439-9882

1. Wheel Alignment & Balance
2. Brakes
3. Ignition Service
4. Electrical
5. Air Condition
6. Lubrication
7. Tire Service — Jetzon Tires
8. Official N.Y.S. Inspection Station — All groups
9. AAA Road Service
10. Towing Service
11. Cooling System Problems
12. Gas Tank Repairs

7 A.M.-6 P.M. MONDAY thru FRIDAY • 7 A.M.-1 P.M. SATURDAY

**THE CAPITOL DISTRICT PSYCHIA-
TRIC CENTER** is looking for respon-
sible individuals or couples who
are interested in sharing their
homes with individuals in need of
a warm supportive family environ-
ment. Earn \$208 a month for your
time and understanding.

**Call 445-5552
Monday-Friday**

Back to School SPECIALS

**WE HAVE SOME
EXTRA-SPECIAL WOOL BLENDS FOR JUMP-
ERS, SKIRTS AND OUTERWEAR AT UNBE-
LIEVABLE PRICES.**

Wool/Nylon
Plaids, Stripes,
Novelties
60" wide
2.99 yd.

Value to 4.99

Wool/Nylon
Meltons for
Outerwear
60" wide
4.99 yd.

Value to 7.98

Wool/Nylon
Blanket Plaids
60" wide
3.50 yd.

Value to 4.98

"Crompton"
Corduroys
The finest —
prints and solids
from 2.69

**BUY QUALITY FABRICS — THEY COST LESS
IN THE END.**

DELMAR DECORATORS

Delaware Plaza, Delmar • 439-4130

DAILY 10-9

SATURDAY 10-5:30

Tools

RESTAURANT

283 DELAWARE AVENUE, DELMAR • 439-9111

AN IDEA

Let the "sweet lady" sleep today and have a
5-Star Breakfast at Tools:

Two eggs, any style

Juice or Home Fries

Bacon, ham or sausage

Toast with jelly

Coffee (the best coffee in town)

\$1.75 until 11:00 A.M.

— No Finer Food Served Anywhere —

OPEN 7 A.M.-8 P.M. — CLOSED SUNDAY

Better still,
bring her
along!

Fishing Boat Rentals

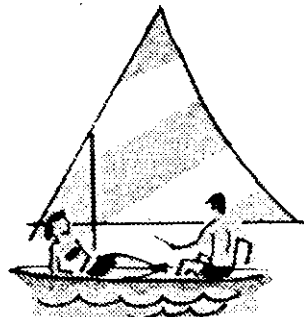

Boat Storage

GABRY'S MARINE SALES

16 Lincoln Ave., Watervliet — 273-6888

Call us first. It'll keep you from digging yourself into a hole.

Telephone cables are often
where you least expect to find them.
So are gas and power lines.

So before you do any digging for
your farm, well or building site, check
with the Capital Area Underground
Utilities Locating Service. The number
to call is 374-9908.

If you hit a cable, you won't

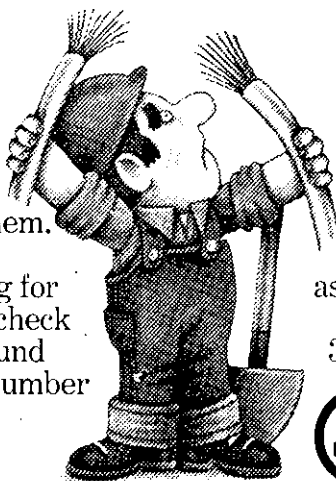

only cause yourself trouble. But a
lot of other people who desperately
need phones, gas and electricity. Such
as hospitals, fire and police departments.
In the Capital District Area, call
374-9908. If it's a toll call, call collect.



New York Telephone

George H. Phelps, Pastor
Joseph V. Farrell, Organist

THE BROTHERS OF FRANCIS OF ASSISI!
The Chapel of Regina Pacis
"Queen of Peace"

19 Central Ave., Ravena, N.Y.
756-6990

Bro. Carlo of John — Pastor

11 A.M. — Morning Worship
7:30 P.M. — Wed. (Devotion to the
Univ. Blessed Mother)
"Everyone Welcome"

**COMMUNITY UNITED
METHODIST CHURCH**

1497 New Scotland Road

Slingerlands, N.Y.

Bryson M. Smith, Pastor

10:00 A.M. Divine Worship
10:00 A.M. Church School
(Nursery & Child Care provided)
"All Welcome"

GUEST EDITORIAL

No more than we should relegate the moral education of our children solely to schools and religious institutions, should we leave the study of our national heritage solely to our educational institutions. Love of country and dedication to its principles are not learned in the twelfth grade government class, but in the sights and sounds of growing up in a family that cares about flying the flag, watching the Memorial Day parade, enjoying the trips to the Old Stone Fort, Saratoga Battlefield, Shelburne Museum, the Altamont Fair.

Those principles upon which our country was founded were considered radical by the rest of the world at the time of their declaration. At that time in history only radical thinkers would have stated that "All men are created equal, and they are endowed by their Creator with certain unalienable Rights, that among these are Life, Liberty and the pursuit of Happiness."

Read the Declaration of Independence again — it is only three paragraphs long. Think of the tortuous path and inner struggles of the Founding Fathers that led to that decision.

Tell your children about their great grandparents and great-great grandparents; what lands they came from, why they came to this country and under what conditions. If you do not know, ask older members of the family.

Talk to your teenagers about our Viet Nam War casualties in Canada. Let them know how you feel. Find out what their opinions are.

Buy an American Heritage book about our country's history. If your children are not old enough to read, they can look at the pictures.

A perfect opportunity to think especially about our country is during Constitution Week. How long has it been since most of us have read the Constitution?

September 17 through 23 is Constitution Week, so designated by Public Law #915 in 1956. This year we will be celebrating the 187th birthday of the adoption of our Constitution. On September 17, 1787, 39 delegates from 12 of the original states, meeting in Phila-

**NO FINER
TRIBUTE**



**MEMORY
STUDIOS**

1032 Central Avenue
Only authorized
Rock of Ages Dealer
in Albany County.
438-4486



Our Name

Inside a Diamond Ring
means better value—
We guarantee it...



FRANK H. Adams
JEWELERS - SILVERSMITHS

MEMBER
AMERICAN GEM SOCIETY

Corner North Pearl &
Streiten St., Downtown Albany

FREE SAFE PARKING
BEHIND GRANTS

FREE!

Buy 4 gallons, get another free! Choose either
of these great Olympic exterior finishes:

STAIN

For new wood or re-do, OLYMPIC STAIN is one of the most beautiful things you can do for wood. It lets the natural grain and texture show through while it penetrates for protection. And it never cracks, peels or blisters. Buy 4 gallons now, and we'll give you a 5th gallon free!



\$8.75
Gallon

OVERCOAT

OLYMPIC OVERCOAT is a new acrylic latex product in 18 colors for old painted surfaces and new hardboard. It covers like crazy—even light-over-dark, one coat is almost always enough! Overcoat also applies on damp surfaces. Act now, get a free gallon with a 4-gallon purchase!



\$9.95
Gallon

**Karl A. Paulsen & Sons
LUMBER & MILLWORK**

438-6811

Railroad Ave., Albany, N.Y.

**King
Krest**

Thatcher Park Road
Voorheesville

Serving
Cocktails and Dinner
Fridays, Saturdays and Sundays

OPEN 5:00 P.M.
Reservations Preferred

— CALL 765-4404 —

3rd ACTION AUCTION
Saturday, Sept. 14th

Booths open 10 A.M.
Auction 12 P.M.

Christ Lutheran Church
1500 Western Ave., Albany
Auctioneers Blodgett & Dunn

USED CLOTHING
BAKED GOODS
PLANTS
WHITE ELEPHANT
HANDCRAFTS
REFRESHMENTS

DEITCHER'S INC.
WALLPAPER

FACTORY OUTLET
all brands for less
1st QUALITY
SAVE \$\$\$
40 thousand
rolls in stock
188 Remsen St.
Cohoes, N.Y.
Tel. 237-0101

TROTTA'S RESTAURANT
Delaware Ave.
(2 mi. past 4 corners)
OPEN DAILY 12 NOON
Serving
Hot Lunches
King Sized Sandwiches
Pizza

Eat In Take Out
439-9888

Cape Cod Fence Co.



RUSTIC CEDAR FURNITURE

15% OFF

MONTH OF SEPTEMBER
Picnic Tables, Swing Sets, Chairs
Settees and More

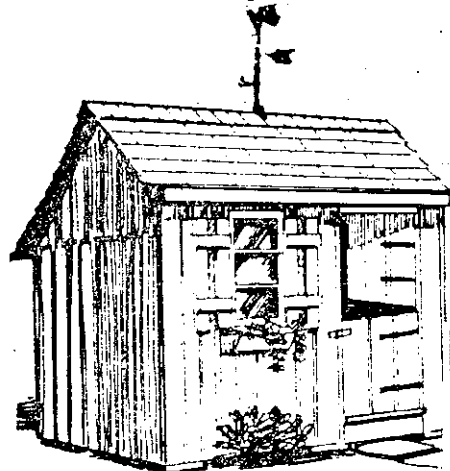

The **HYANNIS**
6'x8'

THE YARMOUTH
MAINE CEDAR FENCES
Shipped Directly from Our Mill Give You Fine Quality

Garden
TOOL HOUSES
10% OFF
MONTH OF SEPT.

LANDSCAPE TIES
Reg. 9.50

\$8⁰⁰ ea.

CHAIN LINK SALE



AVAILABLE IN GALVANIZED OR VINYL

FREE ESTIMATES

SPECIAL
2-Rail
Brewster-Orleans
8 ft. Sect's **\$5⁹⁵ POST & RAIL**



888 TROY-SCHENECTADY RD., LATHAM

PH. 785-0552

Monday thru Thursday 8-5; Friday 8-8; Sat. 8-1

delphia, signed the Constitution of the United States, making it now the oldest Constitution still in active use in the world. This Magnum Opus replaced the weak Articles of Confederation which governed the states from independence in 1781 to 1789 when the new government was convened.

Celebrate Constitution Week by getting a copy of the Constitution in the library or in an old history book and start reading. There are only seven Articles and twenty-six amendments but what a wealth of insight and foresight they harbor. Read again the rights, privileges, and duties guaranteed to us under the Constitution.

George Washington, in his "Farewell Address" said,

"This government, the offspring of our own choice, uninfluenced and unawed, adopted upon full investigation and mature deliberation completely free in its principles, in the distribution of its powers uniting security with energy, and containing within itself a provision for its own amendment, has a just claim to your confidence and support."

We can only feel love of country by knowing and understanding its principles and history. Let's foster that knowledge in our children!

Norma Shiatte
Constitution Week
Chairman
Tawasentha Chapter
DAR

Please write your pet peeve, humorous anecdote or guest editorial to:

SPOTLIGHT
Box RSVP
154 Delaware Avenue
Delmar 12054

LIBRARY NOTES

Riddle Exhibit

To isolate the important and to convey to the viewer what he sees as interesting and beautiful is the purpose of the photographs of Paul Riddle which are on display at the Bethlehem Public Library through the month of September.

Mr. Riddle, a resident of Delmar is studying Photography at Ohio University.

This exhibit consists of photographs, black and white and color, taken in the area surrounding Athens and south-eastern Ohio.

Also on exhibit in the Bethlehem Public Library during September are Apothecary Memorabilia from the collection of Dr. Lawrence M. Gifford. These are in the display case near the Circulation Desk.

Now that school is back in session, it is time to think about homework and research assignments. The Bethlehem Public Library has a new reference tool to help all you downtrodden students. The Library has the brand new 15th edition of the **Encyclopaedia Britannica**. This encyclopedia is a new concept and a complete revolution in encyclopedia making. It is more than a reference work, it is an educational instrument also.

For research, or merely curiosity about a new concept in encyclopedias, stop in the Bethlehem Public Library to see the new **Encyclopaedia Britannica**.

Look what we found! IN THE MAILBAG

Dear Sir:

On behalf of the Bethlehem Tomboys, I would like to thank you for the excellent coverage Spotlight gave our Tournament in its most recent issue. The photographs were especially appreciated.

Sincerely,
Irving Van Woert Jr., M.D.
Chairman, Tournament
Committee
Bethlehem Tomboys

The Spotlight Goes to School

Open House — Elsmere School
Grade 5 — Thursday, September 19 at 8 P.M.

Grade 4 — Tuesday, September 24 at 8 P.M.

Grade 2-3 — Thursday, October 3 at 8 P.M.

The Spotlight

Grade 1 — Thursday, October 10 at 8 P.M.

Kindergarten — Tuesday, October 15 at 8 P.M.



Delmar Dolphins Victorious

A major victory for the Dolphins at the outstanding area AAU Swim Meet of the year! The 1974 Adirondack District A.A.U. Long Course Championship Meet was hosted by the Delmar Dolphin Swim Club and the Town of Bethlehem Parks and Recreation Department at the Elm Avenue Park 50 meter championship pool on August 23-25.

Winning the "Boys Team Trophy" were the Delmar Dolphin Senior Boys who scored decisively in their age group. These boys also scored a major portion of the 489 boys team points which enabled the Dolphins to win the overall boys team trophy with the highest team score ever attained at this annual championship meet. This victory is impressive as more than 20 swim teams from the Northeastern part of New York State were represented.

The outstanding individual senior swimmer for the Dolphins was Malcolm Cooper who scored 67-1/2 points with a perfect record — winning 9 gold medals.

Nearly 1000 swimmers, coaches, officials and spectators participated in this major meet on a beautiful weekend at the Town Park. A note of thanks to our Town officials for making this meet possible is certainly in keeping with Mr. Kohinke's most cordial welcome to our swimmers and guests who enjoyed the use of our town's outstanding recreation complex for the meet.

Subscribe to The Spotlight



Abbey

ORIENTAL and DOMESTIC

Carpet & Rug Cleaning

Specializing In ...

WALL to WALL

Carpet Cleaning in the Home

Carpet Installation Repairing & Binding

Free Pick-up & Delivery

call 439-9978

FACTORY
27 SHERMAN ST.
ALBANY, N.Y.



1973 Chev Monte Carlo — burgundy, vinyl roof, air conditioned, cruise control, special trim package, low, low miles, save hundreds.

1970 Ford Ranchero — mechanic's special, priced below wholesale.

1972 Ford Mustang — the right car for the right time, priced to sell, with 100% guarantee.

1968 VW Squareback — mechanic's special, priced to sell.

1970 VW Camper — excellent condition, deer-hunter's special.

1974 VW Dasher — automatic, air conditioned, executive car, low miles, save.

1974 VW Dasher — 4-door sedan, air conditioned, low miles, save.

1974 VW Type IV, 4-door sedan, blue metallic, air conditioned, steel belted radials, radio, executive demo, priced to sell.

20 other VW's in stock to choose from, all with the Capitol Volkswagen 100% guarantee.

ROUTE 9W, GLENMONT
463-3141

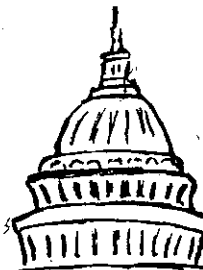

Authorized Dealer

CAPITOL Volkswagen

home of 100% guaranteed used cars

a pint of gas away

where more people buy for less

SERVICE

AT MARSH HALLMAN'S!
ANY CAR WILL GIVE
BETTER PERFORMANCE
AND GAS MILEAGE
WITH REGULAR EXPERT

SERVICE

AT MARSH HALLMAN'S!

**MARSH HALLMAN
CHEVROLET, Inc.**
781 CENTRAL AVE. 489-5551

Open Daily 'til 9 P. M. Friday-Saturday 'til 6 P. M.

Where More People Buy For Less!



SHOWN DIRECTING THE WORKMEN at the new Bethlehem Office of Fidelity Bank and Trust Company are left to right: Patrick J. Ryan, Chief Executive Officer and Chairman of the Board with Orville H. Bennett, Vice President and Herbert L. Shultz, Jr., Second Vice President and Manager of the new office at 354 Delaware Avenue, Delmar. Ryan stated "We are pushing the work so we may have the office opened right after Labor Day."



**DELMAR (439-7083)
DELAWARE PLAZA**

Mon. & Thurs. 10 A.M. 'til 9 P.M.
Tues., Wed., Fri. 10 A.M. 'til 5 P.M.
Saturday 'til 5 P.M.

ALBANY (869-7225)
1549 Central Ave. just West of Colonie Center
10 A.M. to 9 P.M. Daily
Saturday 'til 5 P.M.

CONSOLIDATION SALE

*We are Consolidating our Delaware
Plaza and Colonie Sleep Shops*

**WATCH FOR THE OPENING OF
OUR NEW LARGER SLEEP SHOP
AT 1529 Central Ave., Colonie**

HURRY... EVERYTHING MUST GO!
We don't want to move anything to our
new store.

Sale Prices Effective at Delmar and Colonie ONLY!

SMOOTH-TOP
**MATTRESS OR
BOX SPRING**

TWIN
SIZE
ONLY

\$35

EA. PIECE

20-YEAR GUARANTEE

**QUILT-TOP
MATTRESS OR
BOX SPRING**

TWIN
SIZE

\$70

EA.
PIECE

3/4 or full... \$80 ea. pc.
Extra-Firm

**QUEEN SIZE
SETS**

15-Year
Guarantee
Quilt-Top

\$170

20-Year
Guarantee
Quilt-top
Extra-Firm

\$190

**CONVERTIBLE
SOFA SLEEPERS**

**Every Sleeper
In Stock
On Sale!**

Here & There

TO THE PEOPLE OF THE TOWN OF BETHLEHEM:

A huge measure of thanks is in order for the District voters, from our new adult voters to our senior citizens, for overwhelmingly returning interscholastic sports to Bethlehem Central Schools.

A special vote of thanks to the over 3,000 people who signed enabling petitions, the hundreds of people who got out to the voters to explain the issues involved, all the students who were so eager to help in any way, and to all the concerned people who made the effort to vote.

Your combined endeavors will be fully appreciated by the entire student body. Thank you.

Bethlehem Central
Athletic Assn.

First Male to Join

Sheepishly admitting his chauvinistic membership in the Young Men's Christian Association, James M. Stewart of Albany, today became the first male to gain membership in the Women's Press Club of New York State.

The Women's Press Club which draws its 75 members from the electronic and print media, public relations and advertising, revised its constitution last May, allowing men to join for the first time.

Mr. Stewart, assistant headmaster of Saint Agnes School in Loudonville, was presented a letter of acceptance and welcomed to the club by President Grace Amodeo, public relations director, St. Peter's Hospital, Albany.

Stewart, assistant headmaster for seven years, is a graduate of State University of New York at Albany and currently enrolled in graduate courses. He is a member of the Education Committee of the New York branch, American Civil Liberties Union, the First Unitarian Church of Albany and Citizens for a County Executive.

He and his wife, Martie, reside at 40 Maple Avenue, Albany.

Cooper at Swim Meet

Now what could 17-year-old Malcolm Cooper of Delmar and 14-year-old Mary Beth Pechloff of Kingston have in common?

This weekend, Cooper won all six individual events he entered, just like Mary Beth.

He set four meet records, and led the Delmar Dolfin boys to the team championship.

The performance of these and other local youngsters made it a successful day for the Metroland contingent.

Chicken Barbeque a Success

Selkirk Fire Co. #3 held their annual Chicken Bar-B-Que on Sunday at South Bethlehem Firehouse. The affair was well attended. A great time was had by all.

We wish to thank all those who so nicely contributed to our prizes etc. and also to those who worked so hard to make this occasion a success.

Opens Season

The opening rehearsal of the 1974-1975 season of the Delmar Community Orchestra will be held Monday evening, September 9th at 8 P.M. in the Fellowship room of the First United Methodist Church in Delmar.

New members are welcome to join all present members at this time.

Cocktails & Movies

The Committee to make Jack Barner County Treasurer will host "An Experience in the Theatre" on Tuesday, September 10 at the Fox Theatre on Wolf Rd. in Colonie. Cocktails will be served at 7 P.M. and 10 P.M. The movie "Showdown" starring Rock Hudson and Dean Martin will be shown at 7:30 P.M. and again at 10:30 P.M. Tickets can be obtained by calling Len Goldstein at 869-0269 or Janet Butlin, 439-2210.

Cooperstown Trip

On Saturday, September 21, the Albany YWCA bus, for a day in Cooperstown, leaves from Stuyvesant Plaza near Howard Johnsons at 8:30. All are welcome. Send a check to the Albany YWCA, 55 Steuben Street, Albany, 12207, for \$9.30 to cover buffet lunch and transportation.

Pallone Appointed

John A. Pallone of 17 Altamont Ave., Albany, has been appointed Eastern Division

FENCE FUN Cedar

2 Rail 10' Section	ea. \$7.00
6 x 8 Mill Picket	\$21.74
4 x 8 Mill Picket	\$17.94

WE DELIVER — 765-2377

W. W. CRANNELL LUMBER
Voorheesville

THIS KIND OF

"Blanket Coverage"

ONLY INSURES A COLD HOUSE.

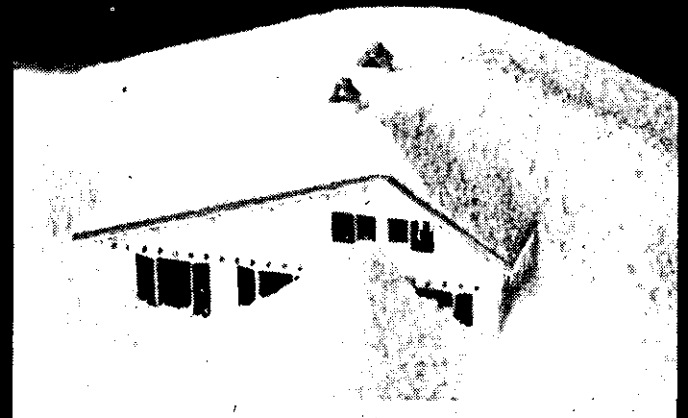

... ESPECIALLY IF YOU WAIT FOR A REAL COLD SPELL TO TEST YOUR FURNACE.

HAVE IT CHECKED NOW!

BY THE BEST TEAM IN TOWN ...

Main-Care *Carrier*

318 Delaware Ave., Delmar, N.Y.
439-7605

DON'T DELAY ... CALL TODAY

Pharmacy Topics



by
Tom
Longtin

Wearers of the new atomic pace-makers are checked once a week — by phone. Their electrocardiograph and pacemaker signals are monitored at the hospital in Newark, N.J., where they were installed.

...

Can't forget to take a pill with the new reminder just patented. Pill box has a timer and buzzer; its alarm reminds you of pill-taking time, and keeps buzzing until you reset it.

...

If the prescription's THAT important, have it filled pronto at New Scotland Pharmacy. Your health is our business.

New Scotland Pharmacy, Inc.

Phone 439-6551
Stonewell Shopping Center
Slingerlands, N.Y. 12159



Here's Something Worth Shouting About!

Our extra care in your remodeling is what makes the difference.

FOR A FREE ESTIMATE
CALL ANYTIME
767-9387



HOME REMODELING HEADQUARTERS
ONE CALL DOES ALL
ESTIMATES • FINANCING • CONSTRUCTION

- Kitchens
- Bathrooms
- Heating Systems
- Family Rooms
- Roofing & Siding
- Room Additions
- Floors & Carpets
- Doors & Windows
- Interior and Exterior Work

ROUTE 9W • SELKIRK, N.Y.

Manager of Training for Niagara Mohawk Power Corporation, it was announced today by William J. Donlon, vice president and general manager.

A native of Albany, Mr. Palone is a graduate of Christian Brothers Academy and Hudson Valley Community College. He is currently attending the College of St. Rose at Albany. He is married to the former Sally M. Walsh of Colonie, and the couple has three children, Anthony, Joseph and Diane.

Proclamation

The underlying purpose of "Citizenship Day" and "Constitution Week" is to strengthen a Nation dedicated to liberty and justice.

WHEREAS impressive civic ceremonies were carried out in several large cities as early as 1915 and

WHEREAS during the period of the celebration of the Sesquicentennial of the Formation of the Constitution (1937-1939), many groups paid particular attention to the subject of citizenship and

WHEREAS in 1939 the Immigration and Naturalization Service supported a movement to establish a specific day for national recognition of United States citizenship and

WHEREAS in 1952 the United States Department of Justice supported the proposal to establish "Citizenship Day" and

WHEREAS in two Joint Resolutions the Congress authorized the President to issue annually proclamations calling for the observance of "Citizenship Day" and "Citizenship Week"

NOW, THEREFORE, I, Bertram E. Kohinke, Supervisor, Town of Bethlehem, do hereby call upon the people of our community to display the flag of the United States on Citizenship Day, September 17, 1974 and to participate in ceremonies designed to show the significance of United States Citizenship and the reciprocal rights and duties flowing from the Constitution.

Full Color Film

On Sunday, September 15, 1974, at 7:00 P.M., the Bethlehem Community Church, 201 Elm Avenue, Delmar will present a full color film, "To Russia With Love," produced by Underground Evangelism. The public is invited to see this exciting film of Christians risking

their lives to smuggle Bibles into Russia, of Russian believers worshipping in an 'underground' meeting, and of the lives of Russian people.

To Conduct Auditions

The Capitol Hill Choral Society conducted auditions for its twenty-second season at Mercy High School, 310 South Manning Boulevard, Albany, on September 4th and 5th. The requirements: a good voice and a basic ability to read music. We are in particular need of sopranos and male voices.

To arrange for an audition please call 434-2064 or 674-5457. Auditions will also be held during regular rehearsals on September 16 and 23.

Bowling Leagues

Beginning Thursday, Sept. 26, the Albany YMCA will be sponsoring two adult bowling leagues. One league will be made up of solely male members, while the other will be a mixed, male-female league.

Both leagues will run on Thursday evenings for a total of thirty weeks. Both the 6:30 and 9:00 shifts are available. Individuals interested in joining either leagues need not be members of the Albany YMCA, however a \$5 annual bowling membership will be assessed every non-YMCA member.

The cost of the league will be \$3.50 per week. Interested persons should contact the Albany YMCA at 449-7196 for further information. The YMCA is a cooperating agency with the United Fund.

Annual Tea

The Tri-Village Welcome Wagon Club Annual Fall Tea, will take place on Thursday, September 19th from 1-3 P.M., at the First United Methodist Church, 428 Kenwood Ave., Delmar. This is an opportunity to meet new friends and to hear about the various activity groups.

Babysitting will be provided at the church for a fee. For information on babysitting please call Sandie Flynn, 439-6451 or Linda Duane 439-3685.

Reservations must be made by September 14th. Please call Phyllis Richards at 439-0833 or Lyn Sprague at 439-6128.

Two Officers Honored

Richard J. LaChappelle and Charles O. Daucher, law en-

Bethlehem Art Assoc.

presents

DRAWING AND PAINTING COURSE

Individualized instruction by
EDWIN BECKER

SEPT. 26th-NOV. 21, 1974
Thursday eves. 7-9

Bethlehem Senior High School

3 Outdoor Sketch Classes
Saturday Mornings

\$35 members, \$38 non-members
Mail checks by Sept. 20th to:
Diane Carroll
122 Dumbarton Dr.
Delmar, N.Y. 12054

Questions, call:
Edwin Becker — 439-4134

Designer Fabrics

Luxurious woolsens, silks, cottons, synthetics from Bill Blass, Oscar De La Renta, Christian Dior, etc.

SWISS-BERNINA SEWING MACHINES

SALES & SERVICE

KNIGHT'S

112 STATE ST., ALBANY
3rd Floor 436-1822

Tri-Village Nursery School

Openings NOW for
TWO and THREE

Day Sessions
3-5 year olds

(There are also openings left for the four and five day sessions)

For further information call:

Kathy Frankie
439-3102

forcement officers, were honored at a dinner-dance Saturday, September 7 at BPOE Lodge, by the Bethlehem Elks Organization.

Richard LaChappelle, 25 year resident of the Town of Bethlehem, graduated from Bethlehem Central H.S. in 1962. He attended Albany College of Pharmacy 1962-1966 and joined the Bethlehem Police Dept. March 15, 1968. In Nov. 1968, he was made Narcotics Officer and in Jan. 1971 was made Detective.

He attended Hudson Valley Community College with credits towards Police Science degree. Completed U.S. Dept. of Justice Bureau of Narcotics & Dangerous Drugs course of instruction in June 1971. He also completed various seminars on different types of criminal investigations at the N.Y.S. Police Academy.

Charles O. Daucher enlisted in the New York State Police on May 16, 1948, at Troop G, Troy, N.Y. He worked as a uniform trooper until September 1, 1952 when he was appointed to the Bureau of Criminal Investigation. On September 12, 1957, he was promoted to the rank of Corporal and designated as a Senior Investigator in the BCI on Aug. 10, 1961. He received his permanent rank of Sergeant on April 5, 1962, remaining as a member of the BCI.

He is a native of Leeds, New York, and served in the United States Army from March 1943 to September 1945, at which time he was discharged with the rank of Sergeant. Charlie is married to the former Dolores Stapleton and they are the parents of three children, Eric, age 21, Robert, age 20 and Kathryn, age 19. The family resides in Catskill, N.Y.

Covered Dish Supper

On Tuesday, September 17, Nathaniel Adams Blanchard Auxiliary Unit 1040 will start the new season with a covered dish supper at 6:30 p.m. preceding a brief business meeting. Members are asked to bring a place setting along with their covered dish. A special treat in store for all members attending will be a Cordial Tasting Party. Ed Pierce of the Hiram Walker Company will show a movie and then on with the tasting!

Church School Starts

The Church School program for the 1974-75 church year will begin at First United Methodist Church on Sunday, September 15, at 9:15 a.m. and 11 a.m. The 9:15 program includes babyfold through age four which begins in the classroom, & Kindergarten through Grade 6 for which students go to the sanctuary and then are dismissed to classes. Grades 7-8 meet in the classroom at 9:15 on the third floor.

At 11 a broadly graded program will be held on the third floor for students in grades 1-6. Adult study will be held in room 210.

Residents of the community are cordially invited to be part of this Christian Education Program.

Family Picnic

The Fourth Annual "All Parish" Family Picnic will be held Sunday afternoon, September 15th, from 1 to 7 at the Sunny Acres Day Camp, Elm Avenue Extension.

A new feature this year, especially for the teens, is a Rock Concert, starting at 4 p.m., starring "The New Electronic Synthesized Progressive Rock & Drole Band — Panurge."

There is no admission charge. Door prize tickets for a portable TV, tape recorder, and smaller third prizes may be purchased at the picnic. This will help defray expenses incurred in renting the grounds, etc.

New Scotland Town Park

Residents of the Town of New Scotland may soon be enjoying the benefits of their own town park facilities if the plans of Town Supervisor Steve Wallace become a reality.

According to Mr. Wallace, the town has an option to purchase a tract of approximately 60 acres facing on Swift Road and backing up on the Salem Hills section of Voorheesville which is being considered for this purpose.

The development of this area, which would extend over a period of 7-8 years, is planned eventually to include picnic areas, two ball fields, tennis courts, a swimming pool, bicycle trails and outdoor ice-skating facilities during the winter months.

First priorities will be given to the development of the pic-

nic areas and one of the two proposed ball fields, with an eye towards having these ready for use by the summer of 1975.

Monies for the land acquisition are presently available and consideration of the overall project is being advanced by permissive referendum. The actual park development will be financed by revenue-sharing funds which the town receives from the federal government.

According to Mr. Wallace, with the development spread over a period of time and the availability of the federal revenue-sharing funds, which by law must be assigned to a specific local project, the effect on the town's tax rate would be minimal, if any.

"The way these revenue-sharing funds work, if we don't utilize them for the benefit of our township, we could eventually lose out on time altogether," Mr. Wallace stated.

MUSIC LESSONS

Piano, Organ, Theory & History
Children and Adults
Willing to teach in your home or church.
438-4728 Beverly Parker, Ph.D.

WINES & LIQUORS UNLIMITED

A THOUSAND WINES in stock
A THOUSAND DECANTERS on display
all at discount prices
Rt. 9W, Ravenna • 756-2081

Male drivers, single, under 25
Automobile insurance as low as
\$219

immediate FS-21 E-Z payments
rates courtesy of Countrywide Ins. Co.

BARRY SCOTT INSURANCE AGENCY
90 STATE ST.
ALBANY, N.Y.

462-9796

462-9891

We'll make your motor sing



- Engine Tune-up
- Front End Alignment
- Automatic Transmission Service
- Modern Equipment
- Skilled Mechanics

BAILEY'S GARAGE

Phone Delmar HE 9-1446
Oakwood Rd., Elmsere

Celebrate any fall occasion at

La Casa

RESTAURANT

Music Stylings by Beverly, Judy and Bob
Friday, Saturday & Sunday Eve.

Just off 9W on Thatcher St. in Selkirk — 767-9045
Dinner served 7 days a week — 11:30 A.M. to 10 P.M.



lucky day **FRIDAY the 13th**

TREESCAPE

ARBORCULTURAL SERVICES

HAROLD C. MacINTOSH, Prop.
The People Who Care About Your
Trees & You

- Pruning
- Feeding
- Cabling
- Tree Removal
- Tree Surgery
- Vista Cutting
- Bracing
- Planting
- Wood Lot Improvement
- Stump Removal

24 Hr. Emergency Service

Free
Estimates

439-7147

FIREWOOD

Mail Address: Box 14, Slingerlands,
N.Y. (Zip 12159)

Be creative
be correct...

**COLOR STYLE
YOUR HOME**

with
**PRATT & LAMBERT
PAINTS**

in exclusive Calibrated Colors

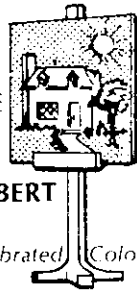

Ed Dillon

EMPIRE PAINT COMPANY

142 Central Avenue
Albany, New York 12206
Phone: 449-5400

SHEAR FARM COUNTRY STORE



**PICK YOUR OWN
APPLES**

for canning & freezing

BRING YOUR OWN CONTAINER
& LADDER

Open 7 days a week
4 miles west of Ravena on Rt. 143
756-2314



A beautiful carved turtle top, marble table,
a brass lamp, greeting cards & candy.

the
COUNTRY TRUNK

Downtown Altamont • 861-8397

Noon to 5 p.m. everyday except Sun. & Mon.

If the plan to purchase the land is successful, the Town of New Scotland would be on its way to joining its neighboring Towns of Bethlehem and Guilderland in providing park and recreational accommodations for their respective residents. At this point, the town would then engage the services of a professional engineer to work on a one-shot, consulting basis in conjunction with the Town Board and the town recreation committee to obtain the maximum utility from the proposed park acreage.

Mr. Wallace commented that while the Swift Road park project will receive the attention at the present time, "hamlet" parks are being considered for other parts of the township to provide basketball and ice-

skating facilities for residents in those areas. He also stressed the fact that the New Scotland landfill on Flat Rock Road could eventually be developed for park purposes when its use as a landfill has been exhausted. "We'd be one leg up on that one," he said, "as the town already owns the land."

Commenting upon the total project, Mr. Wallace said that the idea of a park and recreational area for the enjoyment of Town of New Scotland residents had long been in his mind, and the possibility of accomplishing it without increasing the tax burden to the town's residents — the elderly who are living on fixed incomes and the younger people who are struggling to make ends meet in the face of present-day infla-

Title Topics

HOME OWNER IN A WESTERN STATE WAS STARTLED TO LEARN THAT HIS HOUSE EXTENDED OVER THE BOUNDARY LINE OF ADJACENT PROPERTY... AND THAT A COURT ORDER HAD BEEN ISSUED DEMANDING REMOVAL OF THE ENCRANCHING PORTION OF HIS RESIDENCE. THROUGH HIS OWNERS TITLE INSURANCE, THE ENCRACHED-UPON LAND WAS ACQUIRED FOR HIM WITHOUT THE HOME OWNER SUFFERING FINANCIAL LOSS.

THE PURCHASE OF A HOME IS THE LARGEST INVESTMENT MOST PEOPLE EVER MAKE. IT'S WISE TO LEARN THE FACTS OF REAL ESTATE OWNERSHIP IN ADVANCE -- INCLUDING INFORMATION ON THE PROTECTION OF A TITLE SEARCH AND OWNER'S TITLE INSURANCE.

FOR FREE INFORMATION ON THINGS TO CONSIDER IN BUYING A HOME, WRITE AMERICAN LAND TITLE ASSOCIATION, BOX 566, WASHINGTON, D.C.

American Land Title Association
Box 566
Washington
D.C.

**WE
NEED
HELP
NOW**



**STENOS-TYPISTS
CLERKS**

**Immediate Openings
LONG TERM
SHORT TERM
Apply TODAY**

MANPOWER, INC.

132 State St. Albany 463-4195
406 Fulton St. Troy 272-8600
125 Wolf Rd. Colonie 458-7888

tion — makes it all the more worthwhile.

Youth Soccer Program

The Youth Soccer Program for **boys and girls** in grades 4-8 scheduled to begin on Saturday, September 14, 9-12 a.m., at the Middle School playing fields will not begin until **Saturday, September 21, 9-12 a.m.** Registration fee is \$2.00.

Little Faker

He crams his cheeks with nuts and food,
He has no manners — he's just plain rude,

He eats 'til he can't hold anything more,

— Gertrude Kiley

Manager Appointed

Patrick J. Ryan, Chief Executive Officer and Chairman of the Board, has appointed Herbert L. Shultz, Jr., manager of the Bethlehem Office of Fidelity Bank and Trust Company.

With his wife, the former Cynthia Russell of Rumson, New Jersey, and their son, Christopher, the Shultz' are domiciled in Niskayuna.

The Bethlehem Office will be the fourth office to be opened by Fidelity Bank. An additional five offices will be opened in 1975.

COVER STORY

"COUNTRY FAIR '74"

THIS FAIR IS SPONSORED by local Mount Holyoke College Alumnae and will take place Saturday, September 14, at the Greenberg home, Krumkill Rd., Slingerlands.

NEWS OF TRAVEL

THE QUESTION OF YOUR VACATION

Q. In the interests of the national economy, should I cancel my 1974 vacation?

A. Not at all. It could actually hurt the economy to curtail your travel plans now. The \$61 billion travel industry is a vital branch of American business and if tourism is cut off, the repercussions could effect employment all across the country.

Q. Will the energy crisis make it too difficult for me to make travel plans now?

A. You can still have fun if you make your plans with care—and expert advice. Your travel agent can be a tremendous help. If you're up in the air about transportation, it might put you on cloud nine to know that there are still plenty of airline seats available, and your travel agent is the one who can help you into one of them. He'll also show you which countries are the most economical to see these days, and just how much it will cost. Check to see if the agent is a member of the

American Society of Travel Agents (ASTA), the largest professional travel trade organization in the world. A travel agent will have up-to-the-minute news of planes, prices, schedules, tariffs, surcharges, and practically every aspect of today's complicated travel world where circumstances can vary from



week to week and place to place. He handles information about an armful of travel-connected items, too—hotels, airport conditions, climate, sightseeing, ground transportation, fuel availability, even theater tickets.

Your ASTA travel agent can help you to a terrific trip that won't hurt the economy.

**The
Light
Touch**

A little exercise can make a big difference in your life. Such as a short walk down the aisle.

• • •

The Lord obviously intended us to listen more than we talk — or He would have given us two mouths and one ear.

• • •

True concentration is the ability to do your child's homework while he's watching TV.

• • •

In today's world, about the only thing that can be reached on foot is the garage.

• • •

A fair weather friend is one who appears when he needs you — and disappears when you need him.

• • •

We're always here at Delmar Lumber when you need a power lawn mower.



**END OF SEASON PRICES
ON ALL
MOWERS IN STOCK**

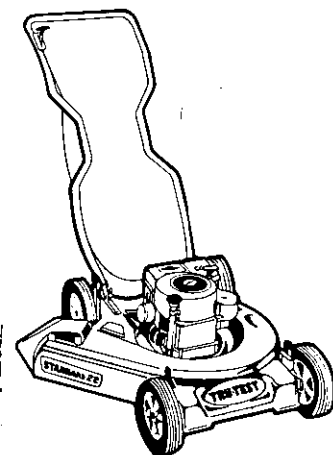

**DELMAR
LUMBER**

340 Delaware Avenue
Delmar
Phone 439-9968



Your "Good Neighbor" for

Home protection

Your home . . . probably your biggest financial investment . . . deserves the best protection. A low-cost State Farm Homeowners Policy with automatic Inflation Coverage can provide all the up-to-date coverage you'll probably ever need. And by offering only the best in protection, service and economy, State Farm's become the world's leading homeowners insurer. Call me for all the details.



ED BERGMANN
50A Delaware Ave., Delmar
482-8771

*Like a good neighbor,
State Farm is there.*

State Farm Fire and Casualty Company
Home Office
Bloomington,
Illinois



MEET A NEIGHBOR



Starting this fall instruction in ART will be available at the studio of TOM McDOWELL, 490 Kenwood Ave., Delmar. Joining with him is PHIL SMELTZER, also of Kenwood Ave. Both men are life-long professional artists.

Mr. McDowell started with a Fine Arts Degree from Syracuse University and was a poster artist with Buckley RKO Theatres in Albany. After about 10 years with the G.E. Co. Advertising Dept. as an artist, he had his own studio in New York City and returned to this area in 1952.

Mr. Smeltzer, originally from Buffalo, has been a recognized artist in this area for many years. Besides his commercial work he has placed in many juried shows and has won prizes not only locally but statewide.

A small Saturday morning class is now forming. Whether you are very young, a Senior Citizen, beginner or advanced, you are invited to apply for instruction in your favorite medium, oil, watercolor, pastel, acrylic. Mr. McDowell's phone no. is 439-1758; Mr. Smeltzer's no. is 439-5319.



JOTTINGS

by
Joni

Such a great satisfaction is that of making your Christmas gifts. If you haven't started yet, you had better get started soon. There are only approximately 14 weeks left.

One thing I enjoy making is candy. It is so much fun to make and not as hard as you may think. The only problem is finding a store that sells candy making supplies such as molds, flavorings and lollipop sticks. If anyone knows of such a store, won't you please let me know. I'm sure there are others who would also like to know.

Get busy and have fun making those gifts.

Marine News

Marine PFC C.K. Stinson, son of Mr. and Mrs. Kenneth Stinson of Route 1, Delmar, participated in "Express Charger," a training exercise near the Marine Corps Base, Camp Lejeune, N.C. He joined with Marines from the Pacific and Atlantic commands, taking part in maneuvers designed to test the operational readiness and coordination of Marine air and ground support units. Stinson serves with the 8th Marine Regiment at Camp Lejeune.

Marine Sgt. William T. Pelletier, son of Mr. and Mrs. William F. Pelletier of 49 Thatcher St., Selkirk, has reported for duty at Marine Corps Air Station at Beaufort, S.C.

Marine Cpl. Jerry J. Fiscoaletti, son of Mr. and Mrs. John Fiscoaletti of 1309 New Scotland Road, Slingerlands, was promoted to his present rank while serving with Force Troops at the Marine Corps Base, Camp Lejeune, N.C.

BRING OUT THE BUBBLY!

Where you find stars, you'll probably find champagne. Celebrity celebrations are usually afloat with the sparkling stuff. And discriminating luminaries—who can afford to drink anything—often chose Moët & Chandon, the royal family of winedom—in many cases just about all the time!

For her dinner party, given by Raoul Griffenwald at Santa Monica's exclusive Le Cellier restaurant, guest of honor Cloris Leachman requested Dom Ruinat. This superb, hard-to-get vintage has long been the famous actress' favorite. An Academy Award winner ought to have good taste, and Cloris certainly has!

It seems that saloonkeepers in Oroville, California (pop. 8,000) are busily stocking up on Dom Perignon, 1969 and other rare years, prior to the filming of *The Clansman*. The movie stars Lee Marvin and Richard Burton, whose Elizabeth is never far behind. Liz drinks only Dom P.—on the rocks. Guess that's one privilege of being a B.P.

But everybody can feel like a Beautiful Person by stocking up on champagne, that wine of wines, and indulging in it whenever a moment of levity strikes!



UNWANTED
HAIR PROBLEMS?

HAS YOUR
ELECTROLOGIST PRICED
YOU OUT OF TREATMENTS?
CALL PAMELA STUART

We Still Maintain Low Prices

Pamela Stuart System

213 Standard Bldg., 112 State St., Albany

Mon. 10 A.M. to 8 P.M.
Tues., Wed. & Thurs. 10 to 7 P.M.
Fri. 10 to 8 P.M.
Call 463-8369
Call or Write for Free Brochure

Christmas in Sept.?

GOOD PHOTOGRAPHS
TAKE TIME — DON'T WAIT
MAKE APPOINTMENTS NOW

767-9891

**RICCARDO
STUDIOS**

108 Maple Ave.
Selkirk, N.Y.

CLOSING FOR VACATION
Sept. 15, Reopening Oct. 11

TROTТА'S

Delaware Ave.
(2 mi. past 4 Corners)

**MONDAY NIGHT
FOOTBALL CLUB**
starts

Mon., Sept. 16 — 8:45 P.M.

Beer . . . Buffet . . . Prizes
Dues \$4.00 per week

FREE SUPERBOWL PARTY

ATTENTION SINGLES

COMPANIONSHIP DATING

AGES 18 to 75
ESTABLISHED MEMBERSHIP

PERSONALIZED
INTRODUCTION
SERVICE

-815 CENTRAL AVE., ALBANY

Call 439-6336

If no answer call 438-1153

Get a new furnace by SINGER before prices heat up.

Drop your worn-out furnace now. Before it drops you. Before temperatures plunge and prices rise. During our pre-season sale, you can save plenty on a gas or oil-fired furnace by SINGER. It's also economical to operate. Provides precise warmth. And you can add SINGER air conditioning to a SINGER furnace any time. For a free estimate call us.

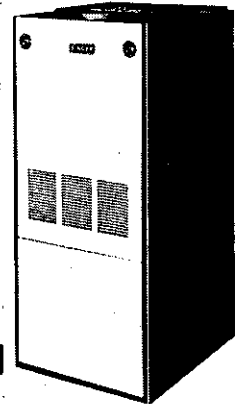

Pre-Season
Sale: **20% OFF**

until Sept. 30th
on any gas or oil-fired
furnace by

SINGER

D.A. BENNETT, Inc.

341 DELAWARE AVENUE, DELMAR

• 439-9966

Don't Let Distance Stand in the Way of Your
Health, Happiness & Success

MRS. ANN
READER & ADVISOR

I Promise
Success



Where
Others Fail

I Will Help You With All Your Problems—
No Matter How Great! Love-Health-Marriage.

518
458-1967

CALL FOR APPOINTMENT

141 Wolf Road, next to DeNooyer Chevrolet
Colonie, New York

Spotlight

CLASSIFIEDS

439-4949

439-4949

Classified Ads are 15¢ per word (\$1.50 minimum) payable in advance before 4 P.M. Friday for following Thursday publication.

Come in person or mail your ad with check or money order to 154 Delaware Ave., Delmar.

(for further information phone 439-4949)

ALTERATIONS

ALTERATIONS AND DRESSMAKING. Jo Clark. 439-4138. tf

ALUMINUM SIDING

COMPLETE LINE aluminum products. Installation. Local references on request. Guaranteed workmanship, free estimates. Dick Domermuth — 768-2429 tf

ALUMINUM SIDING, new plastic coated all colors in stock, no down payment, 30 year guarantee. Free estimates. Statewide Modernization Corp., 104 Quail St., IV 9-0991 tf

APPLIANCES

Bob Sowers' DELMAR APPLIANCE
Complete line of RCA Victor • Whirlpool

SALES & SERVICE
239 Delaware Ave., Delmar
Phone 439-6723

BICYCLES

Meyers Bicycle Center

Sales - Accessories
Repair All Makes

1958 New Scotland Rd. 439-5966



VISTA

DAWES BICYCLES

Parts and Accessories

We repair all makes

BENNETT'S

561 Delaware Ave., Delmar
439-1862

BLACKTOP

MARIANI'S BLACKTOP driveways, garage floors, sidewalks. Also jennite sealer. 489-2780 tf

"Our Prices Are Reasonable"

LIUZZI BROS.

Blacktop Specialists
Residential, Commercial,
Industrial — Fully Insured
Free estimate — 869-6973

CV PAVING, residential, commercial, fully insured, Jennite sealer, all work guaranteed. 439-3645 for free estimate. 2611031

Blacktopping

At prices you can afford. We specialize in driveways, walks, floors, etc. Call for free estimate.
459-5873

BLACKTOP DRIVEWAYS, parking areas, sidewalks, garage floors. Free estimates. 456-1009 or 456-5170. tf

CAPITAL ROAD IMPROVEMENT. Residential, commercial, industrial. Free estimates. Fully insured. 869-3996. tf

BLACKTOPPING
Capitol Paving
Spring Special

Residential
Commercial
Free estimates
All work guaranteed
456-1009 • 456-5170

DON MILLIOUS
CONSTRUCTION

Blacktopping
&
Excavation

Rt. 9W Selkirk, N.Y.
767-2100 767-9775

CARPENTRY

CARPENTRY, stairs, doors, windows, general repairs. Call 6-8 P.M. 756-2019. tf

CARPENTRY — MASONRY — Painting — Repairs — "No Job Too Small". Call Cliff 785-4289. tf

GLUEING, CHAIRS, tables, beds, etc. Expert work, call Dick at 462-4343. 31919

BOB KIBBEY Contracting: kitchen, bath remodeling, porches, patios, paneling. HE 9-3843. 21912

ADDITIONS, GARAGES, dormers, siding, porches, roofs, small repairs. VanCans, 439-3541. tf

MARFIL CONTRACTORS LTD.

General Contracting
Painting Specialists
Fully insured. Free estimates.
Joe Koonce — Rick Cooke
767-9815

COVENTRY, CARPENTRY, cellar to roof, remodeling, kitchen, garages, additions. 439-6042. tf

ADDITIONS, roofing, aluminum siding, framing, enclosures, small jobs, repairs. Masonry. 439-1593. 41103

CHILD CARE

LOVELY COUNTRY HOME. 24 hour service. 50¢ per hour. 767-9537. tf

ELECTRICAL CONTRACTORS

DUFFY ELECTRIC — residential & commercial wiring — 24 hour emergency service. 439-5177. tf

FIREPLACE WOOD

MIKE SHULTES' mixed, dry, hardwood. \$20.00 a face cord, delivered. 872-1495. 41912

FIREWOOD. Seasoned hardwood. Face cord \$45. delivered. 439-6170.

FURNITURE REFINISHED

EXPERT FURNITURE refinishing. Drapes made to order. Also antiques for sale. Phone 768-4664. tf

GLASS

HELDEBERG GLASS, Inc.

43 Main St., Voorheesville • 765-2470
window glass • mirrors • plate • safety and tempered • thermopane • Lexan • Acrylic plastic • auto glass installed • glass tops for furniture & desks • storm doors & windows screening replaced

HORSES BOARDED

JOSEPH'S TROUBADOUR STABLES, riding lesson pony rides. Training. Rt. 9W. 767-9537. tf

TORCHY'S TACK SHOP

Jericho Rd., Selkirk
RO 7-2701 • RO 7-2468
Mon.-Sat. 9-9
Boarding & Training Stables
Riding Supplies & Saddles
Indoor Arena

RINGS, JUMPS — pastures; lessons English only; call 869-2482 or 482-0626. Roundabout Farm. tf

INSTRUCTION

PIANO LESSONS

given by **Anne Louise Rizzuto**
Experienced Teacher
**Theory, Classical &
Keyboard Harmony**
439-0467

CLASSIQUE DANCE SCHOOL

154 A Delaware Avenue
CHILDREN AND ADULTS
PRIVATE OR GROUPS
All types of Dance and Exercise
439-3331 Mrs. B. Follett

LAWNMOWERS

LAWNMOWER SALES
Repairs — most makes
pick-up & delivery
MEYERS LAWNMOWER CENTER
1958 New Scotland Rd.
439-5966

Bill's Elm Ave. Mower Service
Small Engine Repair
Lawnmowers & Snowblowers
Serviced & Sharpened
Also used Mowers for Sale
439-3349 Wm. VANKEMPEN

INTERIOR DECORATING

INTERIOR DECORATING — Delmar Decorators, Delaware Plaza, Call 439-4130 tf

JEWELRY

EXPERT WATCH AND JEWELRY REPAIRS. Diamond setting, engraving, wedding and engagement rings, reasonable. Your trusted jeweler. LeWanda, Delaware Plaza Shopping Center. HE 9-9665. tf

Antiques

at
JEANNE VAN HOESEN'S
Sign of the Coffee Mill

67 Adams Pl., Delmar
439-1021

MASON WORK

EXPERIENCED, all types masonry, new or repairs. Guidara. HE 9-1763 evenings. tf

AREA MASONRY

Specialize Concrete work, additions, floors, patio, walks, foundations

All types of repairs Chimney, stucco, slate, waterproofing, etc.
• Free estimate •



459-5873

CONCRETE FLOORS, walks, steps. Block and brick work; chimneys, repairs, small jobs. Carpenry. 439-1593. 41103

MOTORCYCLES

YAMAHA • TRIUMPH MOTORCYCLES

Sales & Service Parts & Accessories
DAVE FLACK

Rt. 9W, Ravenna • 756-2900

MOTORCYCLE REPAIRS

We service all motorcycles.

Parts & Accessories

CHUCK LONG — 439-3496

Mon.-Tues.-Wed. after 6 P.M.
Other days 10-8

PAINTING & PAPERHANGING

VOGEL, PAINTING Contractor, interior, exterior painting, paperhanging. Free estimates. Guaranteed. Insured. JIM HE 9-9718 or JOHN HE 9-7922. tf

BILL WRISTON

PAINTING CONTRACTOR

• Fully Insured
Residential Experts
Paper Hanging
459-2537 or 439-3166

3 TEACHERS

"Reliable"

Interior-Exterior Painting
10 years experience

Free estimates • Insured
374-8858

D.L. CHASE

Painting Contractor

Residential Specialists

Phone 768-2069

PAINTING CONTRACTOR: exterior, interior, paperhanging. Insured. Don Vogel. 489-7914, 434-8370. tf

ORIENTAL RUGS

ALL SIZES AND Varieties at importer's prices. New, used and antiques; washing and repairing; free decorator advice; new Colonial showroom; since 1925, Rustam K. Kermāni Company, 1593C Central Ave., 1 1/2 mile west of Northway). 869-7829, 439-9419. tf

PRINTING & MAILING

OFFSET PRINTING — Mailing Service — Mimeographing, Typing, G. Bloodgood — Mimeo Service, Delmar, N.Y. 439-3383. tf

PLUMBING

B. P. WOOD
Plumbing & Heating
24 Hour Service
Phone 439-9454

BOB KIBBEY Contracting: all types of plumbing installation, repairs. HE 9-3843. 2t912

MOVERS

D. L. MOVERS, INC. 439-5210. Local and long distance, no job too small. tf

DAN DONNELLY MOVING and trucking. Delivery service. Free estimates. 767-2711. tf

SEPTIC TANK SERVICE

NORMANSKILL SEPTIC TANK Cleaners. We install dry wells, septic tanks, drain fields. 767-9287 tf

DELMAR SANITARY CLEANERS. Service Tri-Village area over 20 years. HE 9-1412. tf

ROOFING

M & V ROOFING

Glenmont

ALL TYPES OF ROOFING

Residential • Commercial

All work guaranteed.

463-5093

ASPHALT, slate, wood shingle, ice slides, gutters, repairs. Van Cans — 439-3541. tf

Roofing Roofing Roofing
Roofing Roofing Roofing
Roofing Roofing Roofing
Roofing Roofing Roofing

**SHINGLE, FLAT
HOT ASPHALT,
COMMERCIAL AND
RESIDENTIAL**
Emergency Repairs

Roofing
Roofing
**RICHARD
MARTIN, JR.**
Roofing
Roofing
765-4468
Roofing

SPOOR & SHELHAMER ROOFING

756-2231 — 767-2334
Talk to the men who do the
work for a free estimate on
A NEW ROOF

BOULEVARD DECORATORS

Specializing in custom made
REUPHOLSTERY

(10 day delivery)

SLIP COVERS

Fabric or Plastic

DRAPERIES

• Our own workrooms
• Fabrics in stock

SHOP AT HOME
FREE Decorator Service

472-9191

BankAmericard - Master Charge.

REPAIRS

on

TVs, Stoves, Radios — Reasonable Rates
Call MARK SPELLMAN after 4:30
439-4825

MASONS INC.

QUALITY MASONRY

Cement and Plastering
"THE BEST FOR LESS"
Walks and patios, etc.
All types of repairs.

A. Loux — 439-3434

R. Tice — 456-7848

ALWAYS PERSONAL SERVICE

PROMPTLY and PROFESSIONALLY

for ALL of your REAL ESTATE needs including relocating you any place in the U.S. and Canada.



**Klersy-Ross
Realty, Inc.**
439-7601

"A NUMBER IT PAYS TO CALL"

HIGH VALUE USED TRUCKS & EQUIPMENT



1968 Intl. 1700 Cab and Chassis
1972 Intl. 1510 Platform Dump
1970 Intl. 1600 16' Van
1972 Intl. W/Refrigerated Body
1971 Intl. 1600, 205" Wheelbase
1973 Dodge 200 4WD W/Plow
1973 Intl. 1010 Travelall
1972 Intl. Travelall 4WD, W/Plow
1972 AMC Matador Station Wagon. Low Mileage
1972 Intl. 1010 Travelall
1970 AMC Ambassador, 4 Dr. Sedan
1971 Ford 4-Dr. AR/S

1969 Chev. C-20 Mobile Home

Good selection of New and Used lawn and garden tractors

COME IN AND TALK TO . . .
Ted Hans Walt Connors

H.L. GAGE SALE, Inc.

ALTAMONT, N.Y.

861-5604, 861-8521

Register Now for Fall Classes

ALBANY YWCA

55 Steuben St.

AQUA BABIES — JUDO
YOGA — BELLY DANCING
FENCING — MECHANICS
"FIX-IT-YOURSELF", etc.

Call 449-7184 to register
and information

CLARA'S RESTAURANT

(8:00 A.M.-3:00 A.M.)

Pizza — Sandwiches
Legal Beverages

SATURDAY NIGHT
Music Dancing

Featuring
"THE SOUNDS"
9:30 P.M.-2:00 A.M.

445-9557

Rt. 9W, Glenmont, N.Y.

TENNIS RACKETS
Restrung — Regripped
VIOLINS REPAIRED
BOWS REPAIRED
C.M. LACY 3 Becker Terr.
439-9739

**BUYING OR
SELLING PROPERTY?**

John J.
Healy
439-7615



FIREWOOD

5 x 8 x 18
DELIVERED

ART ROSE

439-6437
462-9059

Master Charge BankAmericard

DELMAR SPLIT LEVEL



Unique and exceptional four bedroom home, contemporary and modern design, situated in Hamagrael area. Not for everyone's taste — aren't you glad? Slate entrance foyer leads to panelled family room with raised hearth fireplace and panelled den. Spacious kitchen features a self-cleaning oven and bright and cheerful breakfast area with exceptional view. Large formal dining room and living room with wall to wall carpeting, 2-1/2 baths and two car garage. Air conditioned too! Offered at \$64,900. Call now for an appointment.

PAGANO

WEBER

REALTORS

284 Delaware Avenue, Delmar

439-9921

ROOFING



Asphalt, Slate, Built-up,
Wood Shingle, Gutters, Ice
Slides, Repairs, Insured,
Guaranteed.

FREE ESTIMATES
VANCANS
439-3541

SCISSORS SHARPENED

SCISSORS SHARPENED — also lawnmowers,
saws, chain saws, knives, pinking shears, gar-
den tools. 439-5156 or 439-3893. tf

PERMANENT WAVING

SPECIALIZING IN Breck, Realistic Rayette and
Caryl Richards permanents, hair tinting and
bleaching. MELE'S BEAUTY SALON, Plaza Shop-
ping Center. HE 9-4411. tf

TABLE PADS

TABLE PADS — made to order: Delmar Decorators
— 439-4130. tf

TREE SERVICE

HERM'S TREE SERVICE. Call IV 2-5231. tf
BROWNIE'S TREE SERVICE — tree stump removal.
Insured. 456-7660, 456-3373. tf

HERM'S TREE Service, call IV 2-5231. tf
TREESCAPE — Arboricultural Services. 439-
7147. H.C. Mac Intosh, Prop. tf

TRUCKING SERVICE

PIANOS, APPLIANCES, light trucking. Call for
free estimates. 456-3155. tf

WINDOW SHADES

BLIND SHADES in stock and to order — custom
wood-shades and narrow-slat blinds. Delmar
Decorators 439-4130. tf

MERCHANDISE FOR SALE

PIANOS! ORGANS: 150 in stock. Brown Piano Or-
gan Mart. 459-5230. tf

GARAGE SALE: 25 Wiggand Dr., Glenmont. Boys'
clothing shirts, slacks, jackets and suits, like
new, small appliances, toys, men's and ladies'
apparel, suggest your price. September 13 and
14.

DINING SET, CONTEMPORARY, hand-rubbed pa-
tina walnut. Table, (13 leaves), 6 chairs, China.
A walk-away price at \$350. Call 439-3221.

BABY FURNITURE — infant and toddler clothing.
Evenings 439-7180.

FOUR GOODYEAR TIRES: 855-15, 4 ply Polyester
cord, practically new. 439-5372.

BUNDY CLARINET, good condition, \$80. 439-
8649.

ENCYCLOPEDIAS — Funk & Wagnall 25 volumes
plus Hammond World Atlas. \$20.00. 439-
3665.

GARAGE AND STREET SALE, several families, an-
tiques, collectibles, household & misc. Sept.
14, 9 A.M.-6 P.M. Maple Terr., Delmar, off
Delaware Ave., block beyond library.

BABY GRAND PIANO, asking price \$250.00. 439-
0467. 31926

W & J. SLOANE SOFA and slipcover — excellent
condition, reasonable, moving. 439-4385.

1 PAIR USED TIRES, H78x15, low mileage, fine
condition, \$20.00. 439-3815.

LAWN-GARAGE SALE, Sat., Sept. 14th, 10-5.
Something for everyone. West on Delaware
past High School, right on Orchard St.

GARAGE SALE: 17 families. Come spend the day
walking around our block: 1001 items. Antiques
and modern. Sept. 14, 10 A.M.-5 P.M., Merri-
field Subdivision, Harding Ave., Delmar, N.Y.

COLONIAL BROYHILL 88 inch couch and chair.
Perfect for camp or family room, \$100. 439-
7676.

GARAGE-LAWN SALE — 18 McCormack Rd.,
Sling. Sept. 14, 10-4. Stove, dishes, toys,
clothes, flower pots, books, vases, baby &
household items.

GARAGE SALE: Sept. 14, 10-4, corner LaGrange
and Mosher. Boys toys and hobbies.

GARAGE SALE — large variety of interesting
items. Saturday, Sept. 14, 10-5 P.M. No pre-
sales. 5 Oldox Road.

FURNITURE

Our, low-cost, operation policy
enables us to bring you **BIG
SAVINGS** on NEW furniture,
rugs, bedding.

BURRICK FURNITURE
560 Delaware Ave., Albany

Just across the Thruway Bridge
in Albany **465-5112**



NEMER



Rt. 7 West of Latham Circle
Latham, N.Y. • 785-5581

Test drive a
**Front Drive
Subaru**

It could cut your
gas bills
in half.



We could sell it
on gas mileage alone. But
there's so much more. See it and test it at:

**FRED CARL'S
New Salem Garage** INC.

Area's Oldest and Largest

SAAB Dealer!

... with complete parts dept. AND SERVICE!

New Salem, N.Y.
765-2702

KNAPP SHOES. Cushioned comfort. H. Russell Weiss, Glenmont 12077. 465-6091. 20126

BLUE LUSTRE not only rids carpets of soil but leaves pile soft and lofty. Rent electric shampooer 51. Hilchie's American Hardware, 235 Delaware Ave., Delmar. tf

KNAPP SHOES "Sat-Test" Safety Shoes. H. Russell Weiss. 465-6091. 30192

1970 3 BEDROOM LIBERTY Mobile Home, 12' x 60' in trailer park. Skirted, shed included, stove and refrigerator. Reasonable. 767-2168. tf

CREATIVE CAKES by Carol O'Connor. Weddings, birthdays, all occasions. 439-6607. 41926

PETS

House of Pierre

Professional Pet Grooming
239 Delaware Avenue
439-7907 or 439-1800

FREE KITTENS. 2 grey tigers, 5 mo. old. 5 black and whites, 8 weeks old. 439-9429.

AUTOMOTIVE

Prevent **RUST** on new cars. **STOP RUST** on old cars. With our system, we **RUST-PROOF** complete under carriage, inside doors, inside rocker panels, inside trunk. **Appointment only.**
JOE KELLER'S MOBI.
463-7712 • Rt. 9W • Glenmont, N.Y.

JUNK CARS REMOVED, free if complete. Joe Messina's Garage, Selkirk. 767-9971 811010

AUTO BODY WORK — complete paint jobs to minor repairs. Professional work — low price. General auto repair. Fall tune-up special, save on parts and labor. Call 756-9418 10-7 for appointment & free estimate.

1966 CHEVELLE Super Sport hot rod, newly rebuilt 396 engine. New paint job, tires & mags, brakes. Must sell. 439-7676 after 6:00-P.M.

ROOM WITH BOARD

PARENTS BOARDED; lovely country home. Visit with them anytime. 767-9537. tf

WANTED TO BUY

GUNS OF ALL KINDS bought for cash — Moore's Trading Post, 9W, Ravena. 756-2558. tf

COINS — ASSORTED and incomplete collections bought. John Hauf. 439-4007. tf

WATCH REPAIRING

EXPERT WATCH AND JEWELRY REPAIRS. Diamond settings, engraving wedding and engagement rings, reasonable, your trusted jeweler, Lewanda, Delaware Plaza Shopping Center, HE 9-9665. tf

WATCHES REPAIRING, expert workmanship. All work guaranteed. Also engraving, diamond setting watch bands. Harry L. Brown, Jeweler, 4 Corners, Delmar. 439-2718. tf

HELP WANTED

TYPIST — **FIGURE** aptitude. Delmar, 9-5. Call 439-4939 — Equal Opportunity Employer.

BABYSITTER for 4-1/2 yr. old boy, one day (or two) a week. 439-4702.

BABY SITTER — a few days a month for substitute teacher, 16 month old girl. 439-6903. 21919

STUDENT OR WOMAN wanted for light house-keeping & watching 6 yr. old girl Wednesday afternoons starting noon time. Reliable. Own transportation or walking distance. Marlboro Rd. & Lyons. Hamaprael School area. Delmar. 439-7036 after 5:00 or weekends.

HOUSE CLEANER, IRONING, need own transportation. One day a week. Small home. 439-2755. 31912

AVON ASKS...

WANT TO EARN EXTRA MONEY AFTER SCHOOL? If you're 18 or over, sell part-time as an Avon Representative. Fun products for teens too! No selling experience necessary. Call:

Mrs. Calisto, ST 5-9857.

BABYSITTER: my home Delmar. Own transportation. One day or two afternoons a week. Boy (3), girl (4). 439-7916. 21912

REAL ESTATE WANTED

SMALL HOUSE with basement and yard. Unfurnished, unheated, careful family with 2 school-aged children & one dog. 439-6821. 21912

REAL ESTATE FOR RENT

2 BEDROOM APARTMENT at 4 Corners, Delmar, \$85 month. Available immediately. 438-1261 or 439-6090. 21912

PRIVATE ONE BEDROOM, unfurnished upstairs apartment. Wood panelled, fully equipped. Prefer woman or student, available for occasional babysitting. 439-0494.

SEWING MACHINE REPAIRS

SEWING MACHINES REPAIRED. Work guaranteed. Delmar Decorators, 3 Delaware Plaza, Delmar. 439-4130. tf

WELL KNOWN JOHN BESSON repairs all makes of sewing machines, in your home, free estimates. Sells second hand sewing machines, guaranteed for one year. 463-2520. tf

SITUATIONS WANTED

NURSING CARE of elderly, your home, part-time. Nights. 439-1222. 21912

GENERAL HANDIMAN, painting, roofing, panelling, ceilings, and cellars. No job too small. 439-5126. 41919

COLLEGE STUDENT would like part-time work in office or store. Delmar area. Some afternoons, weekends or evenings. Reliable. References. 439-7036 after 5:00 or weekends. 21919

CHILD CARE, my home, 3-5 yrs., excellent references. 439-3568.

MATURE HOUSEKEEPER/COOK, care of elderly or young. Available during Oct./Nov. 439-3213.

BABYSITTING — my home, reasonable, experienced. Day, hour, week. 439-6627. 21919

PRIVACY — SERENITY

Colonial home in New Scotland, 5 minutes from Delmar or Slingerlands. With 11 acres, \$85,000 principles only.

Telephone — 439-1624

NORTHEAST FRAMING

1526 New Scotland Avenue
Slingerlands, N.Y. 12159

NOW OPEN SATURDAY 10-4

Tues., Wed., Thurs. 10 to 4 or by app't.
439-7913 439-6953

M.D.A. FLOOR COVERING, INC.

RIVER RD., GLENMONT
463-8845 — 463-0034

ARMSTRONG — BIGELOW — LEES
CARPETS
ARMSTRONG VINYL FLOORING
Warehouse Discount Prices Always

Vacuum Cleaners are still our only business



Suggestion to our friends in the Delmar area — our new shop-store is just a couple of minutes east of the Everett Rd. Exit of I-90 at the junction of Central & Clinton.

HOPE TO SEE YOU SOON AT 562 CENTRAL AVE., ALBANY

LEXINGTON VACUUM CLEANER REBUILDERS 482-4427

CAT HAVEN FOR CATS ONLY

Reservations Requested

Individual care in Private Home
ETHEL FAY ROCKWELL 5-2715

LOOK FOR OUR OPEN HOUSE

**SAT., SEPT. 21 'til 5
SUN., SEPT. 22, 11-4**

Announcing our appointment as the **newest International Dealer and our 1st Anniversary Sale Tremendous Sales — Values**

To celebrate, we will give away — **\$49 International Edger International electric hedge clipper Many other gifts**

Free Coffee, Donuts, Balloons for the Kids



JOHN S. ALBANO & SONS POWER EQUIPMENT

15 Main St., Ravena 756-2911
M-W-F 8-8, T-Th 8-6, S 8-5

SPOTLIGHT INVITATION

We would like *YOU* to take a more active part in future issues! . . . On the agenda are many plans for special features, ideas and topics which we hope will be of interest to our readers in the broad community that the **SPOTLIGHT** covers.

But we'd like to hear from *YOU*.

Don't you have a **PET PEEVE** — a humorous anecdote — a light-hearted story of local interest to share with us?

(Please keep your contributions **PLEASANT** and not **TOO LENGTHY!**)

SPOTLIGHT would also like to invite interested readers to submit **GUEST EDITORIALS!**

We'll be waiting to hear from you.

Won't you **R.S.V.P.** today?

WRITE: SPOTLIGHT — Box RSVP, 154 Delaware Ave., Delmar.

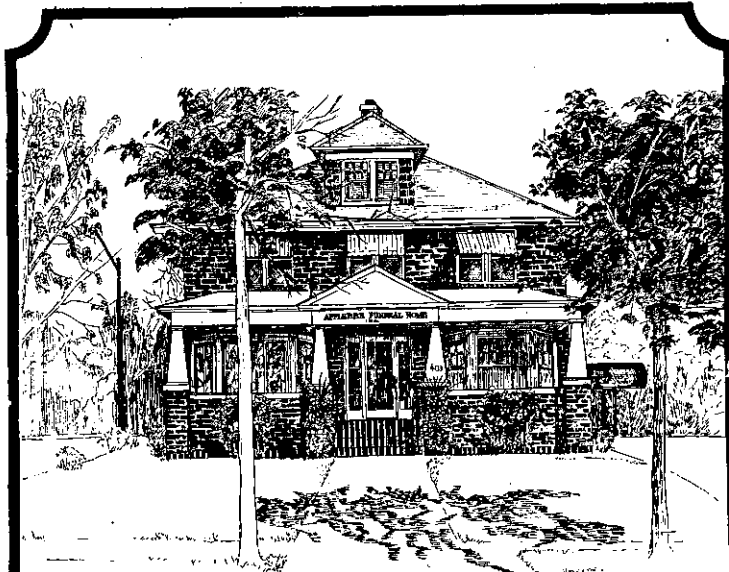

Applebee Funeral Home

Inc.

403 Kenwood Avenue
Delmar, New York

Dorsey Attending FBI Academy

Detective Sergeant Leo E. Dorsey of the Town of Bethlehem, Delmar, who is assigned to the Youth Division said he was never quite sure what the FBI National Academy (NA) in Quantico, Virginia, was all about, but now he knows — work.

Dorsey, 34, a 12-year veteran of the department, is among 247 policemen midway through the exhaustive 12-week course of study and he is convinced that he is a better man for the work.

"The instruction is great because the instructors (all seasoned FBI Agents) take a lot of time with you. I'm going to take a lot back to my department, there is no question about that," Dorsey said.

Organized in 1935, the NA provides in-depth training in a wide range of law enforcement related subjects. More than 8,000 of the finest policemen in this country and nations throughout the free world have successfully completed training at the NA, which is now housed in a spacious and mod-

ern complex about 40 miles south of Washington.

Assistant Director Joe David Jamieson, head of the FBI Training Division, points out that FBI Director C.M. Kelley stresses that the underlying positions and principles of the NA are to enhance a man's progress and prepare him for a role of leadership in law enforcement.

Each of the men attending the NA is exposed to courses in the management sciences, behavioral sciences, and forensic sciences as well as classwork in law, education communications arts, and law enforcement arts. A total of from 14 to 16 hrs. of undergraduate credit can be obtained through the University of Virginia by those completing the course work. Physical fitness is emphasized and attendees participate in a rigorous physical training program.

"Just as important as the classroom work, though, is the affiliation with the other policemen," Dorsey explained. "The friendships I am making will last a lifetime and I am learn-



Hey Gals!
for full Nutrition

BUY

Freikofer's

**BATTER-WHIPPED
SUNBEAM BREAD**

Available Almost Everywhere

ing about law enforcement problems and solutions that are hard to measure in degrees of importance to my career."

When Detective Sergeant Dorsey graduates in September he will return to his department, but the learning process will not end. After graduation

he will become a member of the National Academy Associates, an organization of NA graduates, nearly 5,000 of whom are still active in law enforcement. The members meet at regular intervals to exchange views and information and to rekindle friendships.



THE LATEST IN AUDIO-VISUAL EQUIPMENT is utilized at the FBI Academy by officers attending the National Academy. Here, Sergeant Leo E. Dorsey, listens to a taped lecture on one of many topics offered to the attendees.

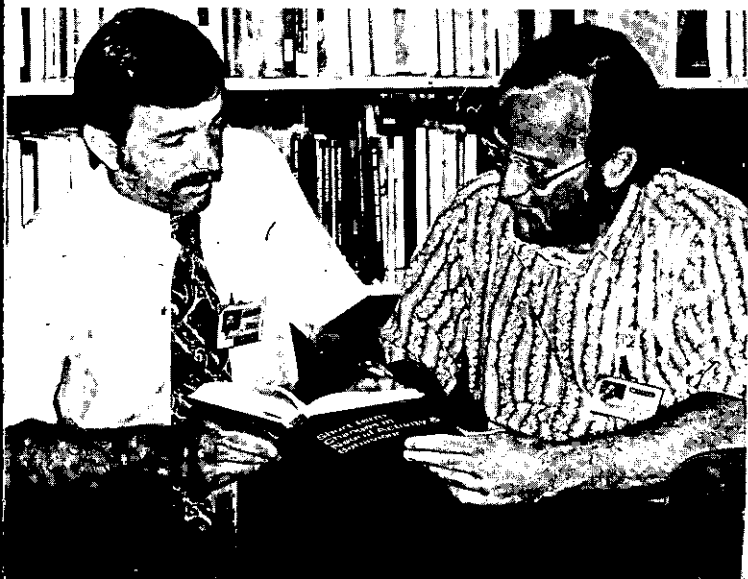

THE LEARNING RESOURCE CENTER at the FBI Academy is the area of much activity for officers attending the National Academy. Sergeant Leo E. Dorsey, like the 246 others attending the National Academy, spends a good deal of his time researching projects.

community corner

POP WARNER SEASON OPENERS

What: Bethlehem "Pop" Warner Jr. Football Teams Opening Games

When: Sunday, September 15, 1974

Where: Junior Midgets at Home versus Colonie at Betelehem Middle School, 2 P.M.

Midgets versus Rotterdam at Mohanason High School, 2 P.M.

The Bethlehem "Pop" Warner Football teams look to another successful season. **Come and give these boys your support.**

BLOODMOBILE

What: American Red Cross Bloodmobile

When: Thursday, September 19, 11:30 A.M. to 5:15 P.M.

Where: Delmar Presbyterian Church, 585 Delaware Ave., Delmar.

No one ever talks about the blood shortage — but there is one. Won't you come over and give just one pint of yours. It would be greatly appreciated.

Community Corner, a public service column of important community events, is sponsored by the people of the

PLASTICS DIVISION

GENERAL  ELECTRIC

SELKIRK, NEW YORK 12158

Sears

Save \$20

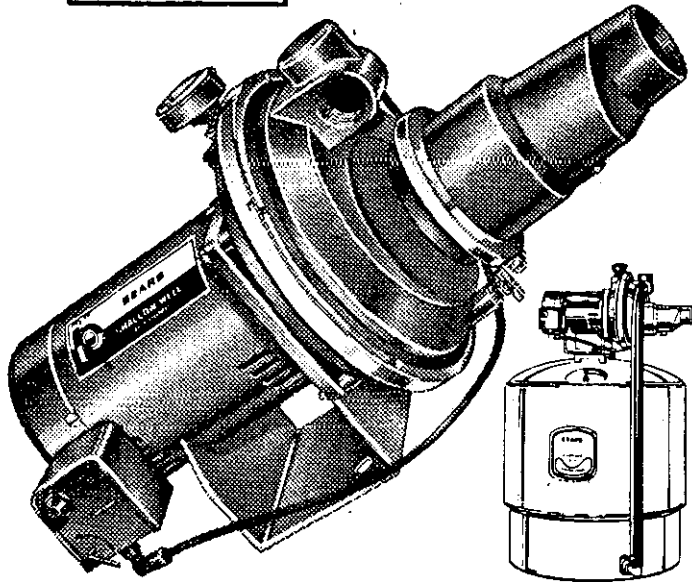

Hydro Glass™ Shallow Well Jet Pump

1/2-HP
Regular \$119.95

99⁸⁸

Now there's a Hydro Glass pump for wells to 20-ft.! It's the most rust-resistant pump we sell, with a Power Bonus motor for dependable performance. Motor has power in excess of rating to hold pressure at 30/50 pounds.

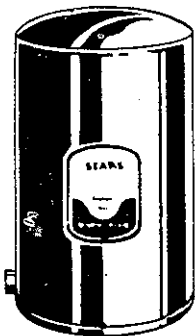

19-Gallon Efficient Captive™ Air Tank

Sears
Low Price

79⁹⁵

This tank can't waterlog under normal conditions because air and water are separated. No air volume control required.

Use Sears Easy Payment Plan

Satisfaction Guaranteed or Your Money Back

SHOP
AT SEARS
AND SAVE

Sears

HOME
OF
HOME

IMPROVEMENT

ALBANY
COLONIE CENTER
Phone 459-8100

SEARS, ROEBUCK AND CO.

LADIES' DAY at DELMAR CAR WASH Every Wednesday

CAR WASH ONLY \$1.25
Reg. \$1.75

WASH & HOT WAX \$2.00
Reg. \$2.50

DELMAR CAR WASH "THE QUALITY CAR WASH"

Located opposite Delaware Plaza
Behind Del Bowling Lanes

439-2839

ELECTRIC TRAINS

Repairs — Parts — Sales
Std., "O", S, HO & N Gauge
CHUCK LONG — 439-3496

Cakes by
Faith Reed
439-5640

available on short notice

DELAWARE COIN SHOP



290 DELAWARE AVE.
(next to Delaware Theater)
Open: 12 Noon-7 P.M.

We Buy and Sell
Gold and Silver Coins
Free Appraisals

463-6111

Country Store For Sale

Ideal location on Main Highway Near Golf Course

GENEROUS SIZED BUILDING INCLUDES
Newly Built Modern Stone Fireplace

GIFTS — VEGETABLES — APPLES
SNOWMOBILES — MOTORCYCLES — BICYCLES

— additional acreage available —
— selling due to illness —

Phone 756-2314 for further details

DELMAR, NEW YORK 12054
431 DELAWARE AVENUE
MR. MICHAEL J. D'ATTILIO

